



PRODUCT CATALOG

COMBINING THE CRAFTSMANSHIP OF THE PAST WITH THE TECHNOLOGY OF THE FUTURE.

Since 1995 Corona Millworks has been proudly serving industry professionals.

CMW continually strives to provide excellent quality, a broad selection, and superior service. This is done in the true spirit of partnership while building long term relationships in the industry. All of our products are produced from the finest materials and each order is custom manufactured to your specifications. We fabricate all essential pieces for your residential and commercial applications at our Southern California facilities. From mill to delivery..

Corona Millworks is the source for craftsmanship, service, and quality for all your cabinet door and component needs.





Cabinet Doors & Drawer Boxes

CONTENTS

Ordering & Product Information	5
Standard Series	7
Designer Series	21
Mitered Series	33
Moulding Series	49
Contemporary Series	58
Louver Series	59
Specialty Options	60
Edge Detail Options	63
E-Series	67
Thermofoil Series	73
Thermofoil Edge Detail & Moulding Options	89
Thermofoil Color Options	93
Drawer Boxes	100
Custom Wood Boxes & Inserts	102
Cabinet Components & Parts	106
Face Frames	117
Corbels	120
Premium Wood Mouldings & Posts	121
Knobs & Pulls	124
Hinges & Plates	127
Drawer Slides & Clips	128
Quick Screws, Spacers & Pins	129
Index	130



ORDERING & PRODUCT INFORMATION



Toll-Free: 800-200-0975

Main Office: 909-606-3288

Fax: 909-606-3270

Email: info@coronamillworks.com

Online: www.coronamillworks.com

WARRANTY INFORMATION

All wood products manufactured by Corona Millworks are guaranteed against warpage or twisting for a period of one year. Doors, drawer fronts, moldings, valances, and fillers, are warrantied by Corona Millworks to the customer against defects occurring in the manufacturing process, and are subject to the terms and conditions as stated in the Warranty certificate.

Corona Millworks also guarantees its Rigid Thermofoil (RTF) products against de-lamination, irregular surface discoloration, warpage or twisting for a period of five (5) years from the date of purchase. The warranty only covers defects as specified herein and does not include defects or damages attributable to misuse or normal surface weathering, defects or damages caused by accidents or fire or other casualty or Acts of God, and any other causes or occurrences beyond the manufacturer's control. The exclusive remedial action provided for the customer hereunder shall be repair, replace, or the return and refund of the products manufactured by Corona Millworks found to be defective.

Visit the Warranty Information page on the Corona Millworks website for more information on all of our warranty inclusions and exclusions.

COLOR

Please Note: Due to the unique characteristics of natural wood, there will be variations in grain and color on your ready-to-be-finished product. Also, due to the nature of printing processes, the colors depicted in this catalog may vary when compared to your finished product.

Specifications and details shown are subject to change. Please contact customer service for questions or more detailed product information.



Featured Door Styles Left to Right: Madison | Orion | Aurora | Vega



STANDARD SERIES

Corona Millworks Standard Series Wood Doors are available in a wide range of species, feature cope-n-stick construction, and are custom built to your specifications.

Additionally, our wood doors are backed by a 1-Year Limited Warranty.

Due to the unique characteristics of natural wood, there will be variations in grain and color on your finished product.

WOOD DOORS

WOOD DOORS



▶
ASHLEY
(1/4" Recessed Panel)
Min Door Size:
7" x 7"
Max Door Size:
30" x 72"
Standard Frame:
2.25"
5-PIECE DF
Min DF Height:
5" (with 1.5" Rails)

Species Shown: Select Alder



▶
MADISON
(Solid Recessed Panel)
Min Door Size:
7" x 7"
Max Door Size:
30" x 72"
Standard Frame:
2.25"
5-PIECE DF
Min DF Height:
5.5" (with 1.5" Rails)

Species Shown: Rift White Oak



▶
DURHAM
(1/4" Recessed Panel)
Min Door Size:
11.5" x 7"
Max Door Size:
30" x 72"
Standard Frame:
2.25"
SLAB DF
Min DF Height:
3.5"

Species Shown: Select Red Oak



▶
ALBANY
(Solid Recessed Panel)
Min Door Size:
11.5" x 7"
Max Door Size:
30" x 72"
Standard Frame:
2.25"
SLAB DF
Min DF Height:
3.5"

Species Shown: Select Alder



◀
ASTRON
 Min Door Size:
 7.5" x 7.5"
 Max Door Size:
 30" x 72"
 Standard Frame:
 2.25"
 5-PIECE DF
 Min DF Height:
 6" (with 1.5" Rails)

Species Shown: Soft Maple



◀
GALAXY
 Min Door Size:
 9" x 9.5"
 Max Door Size:
 26.25" x 72"
 Standard Frame:
 2.25"
 ROUTED DF
 Min DF Height:
 4.5"

Species Shown: PG Poplar



◀
ORION
 Min Door Size:
 9" x 9"
 Max Door Size:
 26.25" x 72"
 Standard Frame:
 2.25"
 ROUTED DF
 Min DF Height:
 4.5"

Species Shown: Knotty Alder



◀
SATURN
 Min Door Size:
 9" x 9.25"
 Max Door Size:
 26.25" x 72"
 Standard Frame:
 2.25"
 ROUTED DF
 Min DF Height:
 4.5"

Species Shown: Select Alder

WOOD DOORS

WOOD DOORS



▶
VEGA

Min Door Size:
7.5" x 7.5"

Max Door Size:
30" x 72"

Standard Frame:
2.25"

5-PIECE DF
Min DF Height:
6" (with 1.5" Rails)

Species Shown: Select Alder



▶
SOL

Min Door Size:
9" x 9.5"

Max Door Size:
26.25" x 72"

Standard Frame:
2.25"

ROUTED DF
Min DF Height:
4.5"

Species Shown: African Mahogany

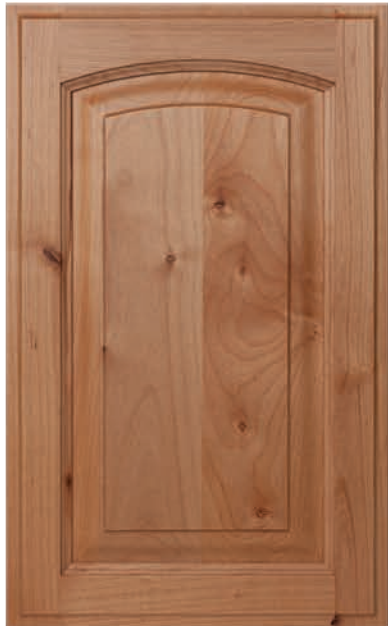

▶
LUNAR

Min Door Size:
9" x 9"

Max Door Size:
26.25" x 72"

Standard Frame:
2.25"

ROUTED DF
DF Min Height:
4.5"

Species Shown: Knotty Alder



▶
JUPITER

Min Door Size:
9" x 9.25"

Max Door Size:
26.25" x 72"

Standard Frame:
2.25"

ROUTED DF
DF Min Height:
4.5"

Species Shown: Select Hard White Maple



◀
ARIEL
 Min Door Size:
 7.5" x 7.5"
 Max Door Size:
 30" x 72"
 Standard Frame:
 2.25"
 5-PIECE DF
 DF Min Height:
 6" (with 1.5" Rails)

Species Shown: African Mahogany



◀
GAMMA
 Min Door Size:
 9" x 9.5"
 Max Door Size:
 26.25" x 72"
 Standard Frame:
 2.25"
 ROUTED DF
 DF Min Height:
 4.5"

Species Shown: Beech



◀
NICOLAUS
 Min Door Size:
 9" x 9"
 Max Door Size:
 26.25" x 72"
 Standard Frame:
 2.25"
 ROUTED DF
 DF Min Height:
 4.5"

Species Shown: Select Cherry



◀
PAVO
 Min Door Size:
 9" x 9.25"
 Max Door Size:
 26.25" x 72"
 Standard Frame:
 2.25"
 ROUTED DF
 DF Min Height:
 4.5"

Species Shown: Select Red Oak

WOOD DOORS





◀
PRISCILLA
 Min Door Size:
 7.5" x 7.5"
 Max Door Size:
 30" x 72"
 Standard Frame:
 2.25"
 5-PIECE DF
 DF Min Height:
 6" (with 1.5" Rails)

Species Shown: Select Alder



◀
VICTORIA
 Min Door Size:
 9" x 9.5"
 Max Door Size:
 26.25" x 72"
 Standard Frame:
 2.25"
 ROUTED DF
 DF Min Height:
 4.5"

Species Shown: Select Red Oak



◀
RUBIO
 Min Door Size:
 9" x 9"
 Max Door Size:
 26.25" x 72"
 Standard Frame:
 2.25"
 ROUTED DF
 DF Min Height:
 4.5"

Species Shown: Select Hard White Maple



◀
SERENA
 Min Door Size:
 9" x 9.25"
 Max Door Size:
 26.25" x 72"
 Standard Frame:
 2.25"
 ROUTED DF
 DF Min Height:
 4.5"

Species Shown: Select Red Oak

WOOD DOORS

WOOD DOORS



▶
HELIO

Min Door Size:
7.5" x 7.5"
Max Door Size:
30" x 72"
Standard Frame:
2.25"
5-PIECE DF
DF Min Height:
6" (with 1.5" Rails)

Species Shown: African Mahogany



▶
AURORA

Min Door Size:
9" x 9.5"
Max Door Size:
26.25" x 72"
Standard Frame:
2.25"
ROUTED DF
DF Min Height:
4.5"

Species Shown: Select Walnut



▶
CORVUS

Min Door Size:
9" x 9"
Max Door Size:
26.25" x 72"
Standard Frame:
2.25"
ROUTED DF
DF Min Height:
4.5"

Species Shown: Select Cherry



▶
LIBRA

Min Door Size:
9" x 9.25"
Max Door Size:
26.25" x 72"
Standard Frame:
2.25"
ROUTED DF
DF Min Height:
4.5"

Species Shown: Rustic Knotty Alder



◀
HARLEY
 Min Door Size:
 7.5" x 7.5"
 Max Door Size:
 30" x 72"
 Standard Frame:
 2.25"
 5-PIECE DF
 DF Min Height:
 6" (with 1.5" Rails)

Species Shown: Select Cherry



◀
PHOENIX
 Min Door Size:
 9" x 9.5"
 Max Door Size:
 26.25" x 72"
 Standard Frame:
 2.25"
 ROUTED DF
 DF Min Height:
 4.5"

Species Shown: Select Red Oak



◀
GEMINI
 Min Door Size:
 9" x 9"
 Max Door Size:
 26.25" x 72"
 Standard Frame:
 2.25"
 ROUTED DF
 DF Min Height:
 4.5"

Species Shown: Select Alder



◀
ANDROMEDA
 Min Door Size:
 9" x 9.25"
 Max Door Size:
 26.25" x 72"
 Standard Frame:
 2.25"
 ROUTED DF
 DF Min Height:
 4.5"

Species Shown: Rustic Knotty Alder

WOOD DOORS

WOOD DOORS



▶
VENUS
 (1/4" Recessed Panel)
 Min Door Size:
 7" x 7"
 Max Door Size:
 30" x 72"
 Standard Frame:
 2.25"
 5-PIECE DF
 DF Min Height:
 5.5" (with 1.5" Rails)

Species Shown: Select Cherry



▶
TRITON
 (1/4" Recessed Panel)
 Min Door Size:
 9" x 8.5"
 Max Door Size:
 26.25" x 72"
 Standard Frame:
 2.25"
 ROUTED DF
 DF Min Height:
 4.5"

Species Shown: QTR White Oak



▶
JOVIAN
 (1/4" Recessed Panel)
 Min Door Size:
 9" x 8"
 Max Door Size:
 26.25" x 72"
 Standard Frame:
 2.25"
 ROUTED DF
 DF Min Height:
 4.5"

Species Shown: Select Hard White Maple



▶
ARVADA
 (1/4" Recessed Panel)
 Min Door Size:
 9" x 8.25"
 Max Door Size:
 26.25" x 72"
 Standard Frame:
 2.25"
 ROUTED DF
 DF Min Height:
 4.5"

Species Shown: Select Cherry



◀
BARBOUR
 (1/4" Recessed Panel)
 Min Door Size:
 7" x 7"
 Max Door Size:
 30" x 72"
 Standard Frame:
 2.25"
 5-PIECE DF
 DF Min Height:
 5.5" (with 1.5" Rails)

Species Shown: Select Red Oak



◀
BONNY
 (1/4" Recessed Panel)
 Min Door Size:
 9" x 8.5"
 Max Door Size:
 26.25" x 72"
 Standard Frame:
 2.25"
 ROUTED DF
 DF Min Height:
 4.5"

Species Shown: Select Red Oak



◀
COLUMBUS
 (1/4" Recessed Panel)
 Min Door Size:
 9" x 8"
 Max Door Size:
 26.25" x 72"
 Standard Frame:
 2.25"
 ROUTED DF
 DF Min Height:
 4.5"

Species Shown: Select Alder



◀
ARLINGTON
 (1/4" Recessed Panel)
 Min Door Size:
 9" x 8.25"
 Max Door Size:
 26.25" x 72"
 Standard Frame:
 2.25"
 ROUTED DF
 DF Min Height:
 4.5"

Species Shown: Rift White Oak

DOOR PROFILES

WOOD DOORS

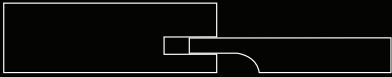

ALBANY
(Has Center Stile)

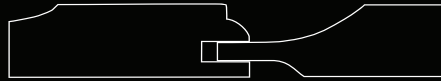

ANDROMEDA

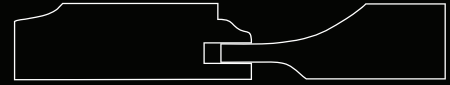

ARIEL

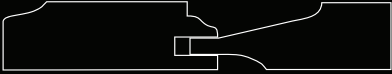

ASTRON

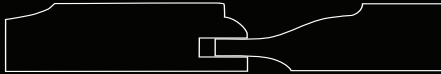

AURORA



BARBOUR

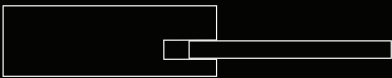

DURHAM
(Has Center Stile)



GALAXY

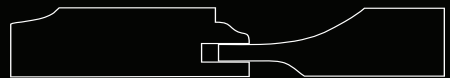

GAMMA

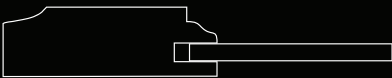

JOVIAN

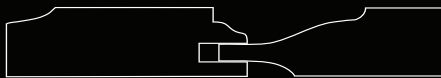

JUPITER

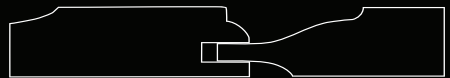

LIBRA

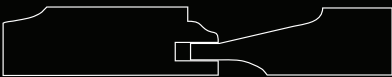

ORION

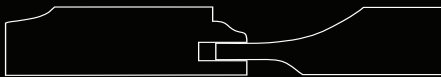

PAVO

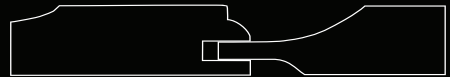

PHOENIX



SERENA



SOL



TRITON

STANDARD SERIES

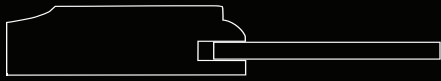

ARLINGTON

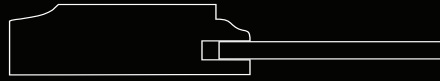

ARVADA

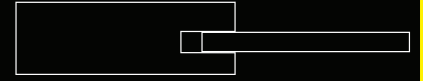

ASHLEY

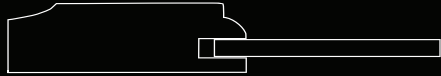

BONNY



COLUMBUS

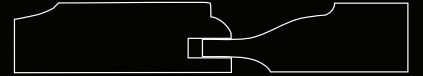

CORVUS



GEMINI



HARLEY

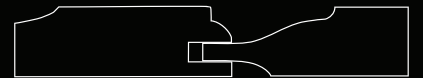

HELIO

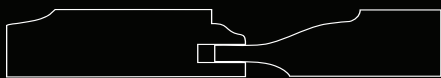

LUNAR

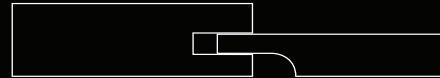

MADISON



NICOLAUS



PRISCILLA



RUBIO



SATURN



VEGA



VENUS



VICTORIA



Featured Door Styles Left to Right: Arroyo | Coronado | Captiva | Santa Rosa



DESIGNER SERIES

Corona Millworks Designer Series Wood Doors feature decorative cope-n-stick details, are available in a wide range of wood species, and are custom built to your specifications.

Additionally our wood doors are backed by a 1-Year Limited Warranty.

Due to the unique characteristics of natural wood, there will be variations in grain and color on your finished product.

WOOD DOORS

WOOD DOORS



▶
CORONADO

Min Door Size:
10.5" x 12"

Max Door Size:
27" x 72"

Standard Frame:
3"

SLAB DF
Min DF Height:
3.5"

Species Shown: African Mahogany



▶
ANTIGUA
(1/4" Recessed Panel)

Min Door Size:
10.5" x 11"

Max Door Size:
27" x 72"

Standard Frame:
3"

SLAB DF
Min DF Height:
3.5"

Species Shown: Select Red Oak



▶
BAHIA

Min Door Size:
9" x 9"

Max Door Size:
30" x 72"

Standard Frame:
3"

5-PIECE DF
DF Min Height:
6.5" (with 1.75" Rails)

Species Shown: Rift White Oak



▶
MONTEGO
(1/4" Recessed Panel)

Min Door Size:
9" x 9"

Max Door Size:
30" x 72"

Standard Frame:
3"

5-PIECE DF
DF Min Height:
5.5" (with 1.75" Rails)

Species Shown: Rift White Oak



◀
SANTA ROSA
 Min Door Size:
 8" x 8"
 Max Door Size:
 30" x 72"
 Standard Frame:
 2.5"
 5-PIECE DF
 DF Min Height:
 6" (with 1.5" Rails)

Species Shown: Select Hard White Maple



◀
PISMO
 (1/4" Recessed Panel)
 Min Door Size:
 8" x 8"
 Max Door Size:
 30" x 72"
 Standard Frame:
 2.5"
 5-PIECE DF
 DF Min Height:
 5" (with 1.5" Rails)

Species Shown: Select Red Oak



◀
MALLAGA
 Min Door Size:
 8" x 8"
 Max Door Size:
 30" x 72"
 Standard Frame:
 2.5"
 5-PIECE DF
 DF Min Height:
 6.5" (with 1.75" Rails)

Species Shown: Rustic Knotty Alder



◀
BROOKS
 Min Door Size:
 8" x 8"
 Max Door Size:
 30" x 72"
 Standard Frame:
 2.5"
 5-PIECE DF
 DF Min Height:
 6" (with 1.5" Rails)

Species Shown: Select Alder

WOOD DOORS

WOOD DOORS



▶
ARROYO

Min Door Size:
7.5" x 7.5"

Max Door Size:
30" x 72"

Standard Frame:
2.5"

5-PIECE DF
DF Min Height:
5.5" (with 1.5" Rails)

Species Shown: Select Cherry



▶
ELITE

Min Door Size:
8" x 8"

Max Door Size:
30" x 72"

Standard Frame:
2.5"

5-PIECE DF
DF Min Height:
6" (with 1.5" Rails)

Species Shown: Select Hard White Maple



▶
LAKWOOD

Min Door Size:
8" x 8"

Max Door Size:
30" x 72"

Standard Frame:
2.5"

5-PIECE DF
DF Min Height:
6" (with 1.5" Rails)

Species Shown: Select Alder



▶
BELLFLOWER

Min Door Size:
8" x 8"

Max Door Size:
30" x 72"

Standard Frame:
2.5"

5-PIECE DF
DF Min Height:
6" (with 1.5" Rails)

Species Shown: Pecan



◀
ALEXANDER
 Min Door Size:
 7.5" x 7.5"
 Max Door Size:
 30" x 72"
 Standard Frame:
 2.5"
 5-PIECE DF
 DF Min Height:
 5.5" (with 1.5" Rails)

Species Shown: Knotty Alder



◀
ALEXIS
 Min Door Size:
 7.5" x 7.5"
 Max Door Size:
 30" x 72"
 Standard Frame:
 2.5"
 5-PIECE DF
 DF Min Height:
 5.5" (with 1.5" Rails)

Species Shown: Select Alder



◀
SYLVAN
 (1/4" Recessed Panel)
 Min Door Size:
 7" x 7"
 Max Door Size:
 30" x 72"
 Standard Frame:
 2.5"
 5-PIECE DF
 DF Min Height:
 5" (with 1.5" Rails)

Species Shown: Select Hard White Maple



◀
CS 467
 (Solid Recessed Panel)
 Min Door Size:
 7.5" x 7.5"
 Max Door Size:
 30" x 72"
 Standard Frame:
 2.5"
 5-PIECE DF
 DF Min Height:
 5.5" (with 1.5" Rails)

Species Shown: Select Red Oak



▶
SCOTTSDALE
 (1/4" Recessed Panel)
 Min Door Size:
 7" x 7"
 Max Door Size:
 30" x 72"
 Standard Frame:
 2.5"
 5-PIECE DF
 DF Min Height:
 5.5" (with 1.5" Rails)

Species Shown: Select Alder



▶
CRANLEY
 Min Door Size:
 7.5" x 7.5"
 Max Door Size:
 30" x 72"
 Standard Frame:
 2.5"
 5-PIECE DF
 DF Min Height:
 5.5" (with 1.5" Rails)

Species Shown: Soft Maple

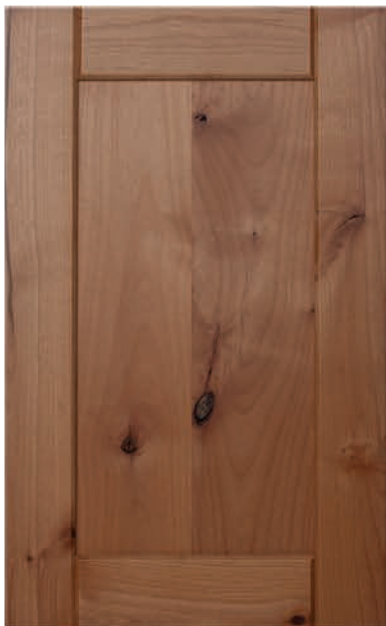

▶
VILLA MARIA
 (Solid Recessed Panel)
 Min Door Size:
 7" x 7"
 Max Door Size:
 30" x 72"
 Standard Frame:
 2.5"
 5-PIECE DF
 DF Min Height:
 5.5" (with 1.5" Rails)

Species Shown: Rustic Knotty Alder



▶
HUGHES
 (1/4" Recessed Panel)
 Min Door Size:
 7.5" x 7.5"
 Max Door Size:
 30" x 72"
 Standard Frame:
 2.5"
 5-PIECE DF
 DF Min Height:
 5.5" (with 1.5" Rails)

Species Shown: Select Hard White Maple

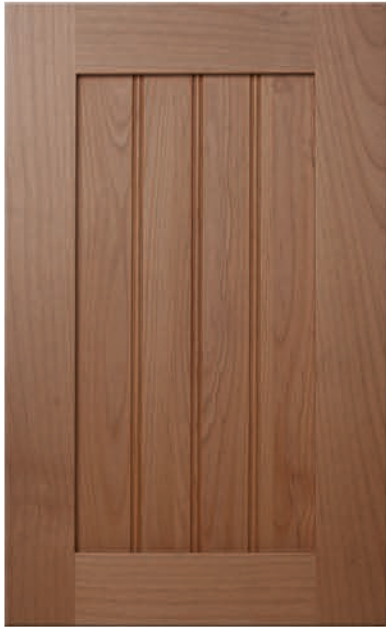

◀
CAPTIVA
 Min Door Size:
 7" x 7"
 Max Door Size:
 30" x 72"
 Standard Frame:
 2.5"
 5-PIECE DF
 DF Min Height:
 5.5" (with 1.5" Rails)

Species Shown: Select Alder

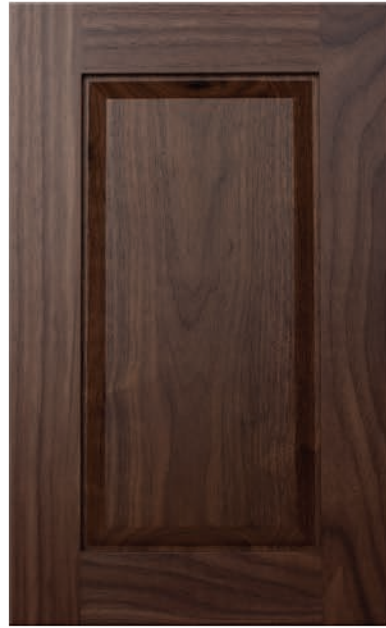

◀
RIVERTON
 Min Door Size:
 8" x 8"
 Max Door Size:
 30" x 72"
 Standard Frame:
 2.5"
 5-PIECE DF
 DF Min Height:
 6" (with 1.5" Rails)

Species Shown: Select Walnut



◀
EMILY
 (1/4" Recessed Panel)
 Min Door Size:
 11.5" x 11.5"
 Max Door Size:
 30" x 72"
 Standard Frame:
 4.5"
 5-PIECE DF
 DF Min Height:
 5.5" (with 1.5" Rails)

Species Shown: Select Cherry



◀
TUSCANY
 Min Door Size:
 9.5" x 9.5"
 Max Door Size:
 30" x 72"
 Standard Frame:
 2.5"
 5-PIECE DF
 DF Min Height:
 7.5" (with 1.5" Rails)

Species Shown: Beech

WOOD DOORS

WOOD DOORS



►
PUFFY

Min Door Size:
9.5" x 9.5"

Max Door Size:
30" x 72"

Standard Frame:
3"

5-PIECE DF
DF Min Height:
6.5" (with 1.5" Rails)

Species Shown: Select Hard White Maple



►
SNOWDEN
(Solid Recessed Panel)

Min Door Size:
8.5" x 8.5"

Max Door Size:
30" x 72"

Standard Frame:
3"

5-PIECE DF
DF Min Height:
5" (with 1.5" Rails)

Species Shown: Rustic Knotty Alder



►
MODESTO
(1/4" Recessed Panel)

Min Door Size:
8.5" x 8.5"

Max Door Size:
30" x 72"

Standard Frame:
3"

5-PIECE DF
DF Min Height:
5" (with 1.5" Rails)

Species Shown: Knotty Alder



►
HANOVER

Min Door Size:
8" x 8"

Max Door Size:
30" x 72"

Standard Frame:
2.25"

5-PIECE DF
DF Min Height:
6.5" (with 1.5" Rails)

Species Shown: Select Hard White Maple



◀
HARVEST
 Min Door Size:
 9.5" x 9.75"
 Max Door Size:
 26.25" x 72"
 Standard Frame:
 2.5"
 SLAB DF
 DF Min Height:
 4.5"

Species Shown: Soft Maple



◀
SEQUOIA
 (Solid Recessed Panel)
 Min Door Size:
 8" x 8"
 Max Door Size:
 30" x 72"
 Standard Frame:
 2.5"
 5-PIECE DF
 DF Min Height:
 6" (with 1.75" Rails)

Species Shown: Select Hard White Maple



◀
ACUARIO
 Min Door Size:
 9.5" x 9.5"
 Max Door Size:
 30" x 72"
 Standard Frame:
 2.5"
 5-PIECE DF
 (Solid Recessed Panel)
 DF Min Height:
 6" (with 1.75" Rails)

Species Shown: Beech



◀
PLACENTIA
 Min Door Size:
 8" x 8"
 Max Door Size:
 30" x 72"
 Standard Frame:
 2.5"
 5-PIECE DF
 DF Min Height:
 6" (with 1.5" Rails)

Species Shown: African Mahogany

DOOR PROFILES

WOOD DOORS



ACUARIO

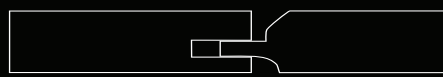

ALEXANDER



ALEXIS

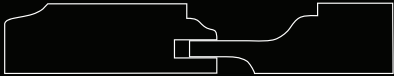

BELLFLOWER



BROOKS

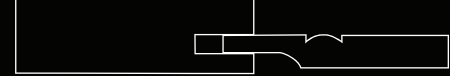

CAPTIVA



ELITE



EMILY

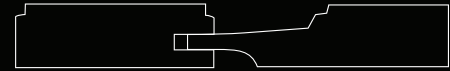

HANOVER



MALLAGA



MODESTO

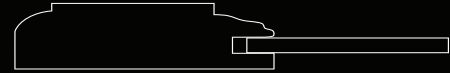

MONTEGO

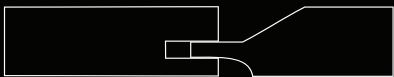

RIVERTON



SANTA ROSA



SCOTTSDALE



TUSCANY

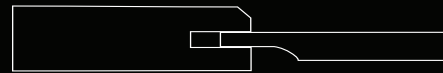

VILLA MARIA



ANTIGUA



ARROYO



BAHIA

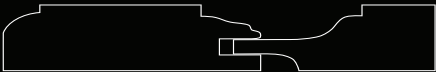

CORONADO

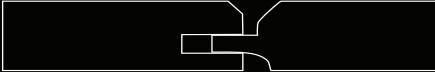

CRANLEY



CS 467



HARVEST

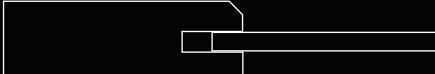

HUGHES



LAKEWOOD



PISMO



PLACENTIA



PUFFY



SEQUOIA



SNOWDEN



SYLVAN



Featured Door Styles Left to Right: Diplomat | Samantha | Manchester | Gardenia



MITERED SERIES

Corona Millworks Mitered Series Wood Doors are available in a wide range of species and are custom built to your specifications.

Additionally, our wood doors are backed by a 1-Year Limited Warranty.

Due to the unique characteristics of natural wood, there will be variations in grain and color on your finished product.



▶
HUNTINGTON
 Min Door Size:
 9" x 9"
 Max Door Size:
 30" x 72"
 Standard Frame:
 3"
 5-PIECE DF
 DF Min Height:
 6.5" (with 1.75" Frame)

Species Shown: Select Red Oak



▶
BOYD
 Min Door Size:
 9" x 9"
 Max Door Size:
 30" x 72"
 Standard Frame:
 3"
 5-PIECE DF
 DF Min Height:
 6.5" (with 1.75" Frame)

Species Shown: African Mahogany



▶
RANCHO
 Min Door Size:
 9" x 9"
 Max Door Size:
 30" x 72"
 Standard Frame:
 3"
 5-PIECE DF
 DF Min Height:
 6.5" (with 1.75" Frame)

Species Shown: Select Hard White Maple



▶
CARMEL
 (1/4" Recessed Panel)
SIERRA
 (Solid Recessed Panel)
 Min Door Size:
 8.5" x 8.5"
 Max Door Size:
 30" x 72"
 Standard Frame:
 3"
 5-PIECE DF
 DF Min Height:
 Sierra: 6.5" (1.75" Frame)
 Carmel: 6" (1.75" Frame)

Species Shown: Select Hard White Maple



Species Shown: Select Alder

◀
LAGUNA
 Min Door Size:
 7" x 7"
 Max Door Size:
 30" x 72"
 Standard Frame:
 2.25"
 5-PIECE DF
 DF Min Height:
 6.5" (with 1.75" Frame)



Species Shown: Soft Maple

◀
CASTLEWOOD
 Min Door Size:
 7.5" x 7.5"
 Max Door Size:
 30" x 72"
 Standard Frame:
 2.25"
 5-PIECE DF
 DF Min Height:
 6.5" (with 1.75" Frame)

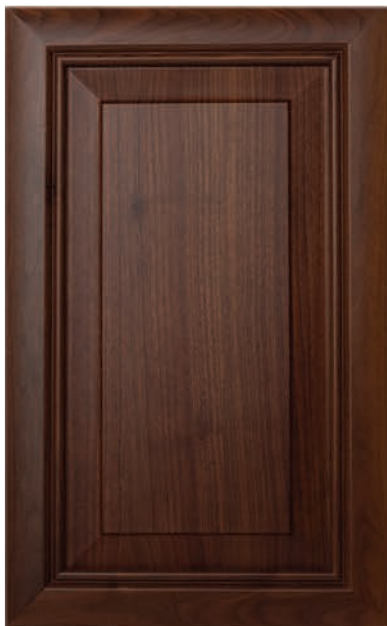

Species Shown: Select Walnut

◀
GARDENIA
 Min Door Size:
 7.5" x 7.5"
 Max Door Size:
 30" x 72"
 Standard Frame:
 2.25"
 5-PIECE DF
 DF Min Height:
 6.5" (with 1.75" Frame)



Species Shown: Soft Maple

◀
WINSTON
 (Solid Recessed Panel)
HERMOSA
 (1/4" Recessed Panel)
 Min Door Size:
 7" x 7"
 Max Door Size:
 30" x 72"
 Standard Frame:
 2.25"
 5-PIECE DF
 DF Min Height:
 Winston: 6.5" (1.75" Frame)
 Hermosa: 6" (1.75" Frame)



▶
NEWPORT

Min Door Size:
8" x 8"

Max Door Size:
30" x 72"

Standard Frame:
2.5"

5-PIECE DF
DF Min Height:
6.5" (with 1.75" Frame)

Species Shown: Select Hard White Maple



▶
VENICE

Min Door Size:
8" x 8"

Max Door Size:
30" x 72"

Standard Frame:
2.5"

5-PIECE DF
DF Min Height:
6.5" (with 1.75" Frame)

Species Shown: Select Cherry



▶
PANAMA

Min Door Size:
8" x 8"

Max Door Size:
30" x 72"

Standard Frame:
2.5"

5-PIECE DF
DF Min Height:
6.5" (with 1.75" Frame)

Species Shown: African Mahogany



▶
SANTA CRUZ
(1/4" Recessed Panel)

GRAHAM
(Solid Recessed Panel)

Min Door Size:
7.5" x 7.5"

Max Door Size:
30" x 72"

Standard Frame:
2.5"

5-PIECE DF
DF Min Height:
Graham: 6.5" (1.75" Frame)
Santa Cruz: 6" (1.75" Frame)

Species Shown: Rustic Knotty Alder



◀
DAYTONA
 Min Door Size:
 9" x 9"
 Max Door Size:
 30" x 72"
 Standard Frame:
 3"
 5-PIECE DF
 DF Min Height:
 7" (with 2" Frame)

Species Shown: Beech



◀
RIO
 (1/4" Recessed Panel)
 Min Door Size:
 8" x 8"
 Max Door Size:
 30" x 72"
 Standard Frame:
 3"
 5-PIECE DF
 DF Min Height:
 6.5" (with 2" Frame)

Species Shown: Select Alder



◀
DIPLOMAT
 Min Door Size:
 9" x 9"
 Max Door Size:
 30" x 72"
 Standard Frame:
 3"
 5-PIECE DF
 DF Min Height:
 7" (with 2" Frame)

Species Shown: Knotty Alder



◀
SHELBY
 (1/4" Recessed Panel)
 Min Door Size:
 8" x 8"
 Max Door Size:
 30" x 72"
 Standard Frame:
 3"
 5-PIECE DF
 DF Min Height:
 6.5" (with 2" Frame)

Species Shown: QTR White Oak



▶
CORTINA

Min Door Size:
8" x 8"

Max Door Size:
30" x 72"

Standard Frame:
2.5"

5-PIECE DF
DF Min Height:
6.5" (with 1.75" Frame)

Species Shown: Select Cherry



▶
KOPER

(1/4" Recessed Panel)

Min Door Size:
7" x 7"

Max Door Size:
30" x 72"

Standard Frame:
2.5"

5-PIECE DF
DF Min Height:
6" (with 1.75" Frame)

Species Shown: Select Hard White Maple



▶
WESLEY

Min Door Size:
8" x 8"

Max Door Size:
30" x 72"

Standard Frame:
2.5"

5-PIECE DF
DF Min Height:
6.5" (with 1.75" Rails)

Species Shown: Rustic Knotty Alder



▶
WESTON

Min Door Size:
9" x 9"

Max Door Size:
30" x 72"

Standard Frame:
3"

5-PIECE DF
DF Min Height:
7" (with 2" Frame)

Species Shown: African Mahogany



◀
SAMANTHA
 Min Door Size:
 9" x 9"
 Max Door Size:
 30" x 72"
 Standard Frame:
 3"
 5-PIECE DF
 DF Min Height:
 7" (with 2" Frame)

Species Shown: Select Hard White Maple



◀
PIPELINE
 (1/4" Recessed Panel)
 Min Door Size:
 8" x 8"
 Max Door Size:
 30" x 72"
 Standard Frame:
 3"
 5-PIECE DF
 DF Min Height:
 6.5" (with 2" Frame)

Species Shown: Select Red Oak



◀
NATHAN
 Min Door Size:
 8" x 8"
 Max Door Size:
 30" x 72"
 Standard Frame:
 2.5"
 5-PIECE DF
 DF Min Height:
 7" (with 2" Frame)

Species Shown: Beech



◀
OGDEN
 (1/4" Recessed Panel)
 Min Door Size:
 7" x 7"
 Max Door Size:
 30" x 72"
 Standard Frame:
 2.5"
 5-PIECE DF
 DF Min Height:
 6.5" (with 2" Frame)

Species Shown: Select Hard White Maple





◀
CAMBRIA
 Min Door Size:
 7" x 7"
 Max Door Size:
 30" x 72"
 Standard Frame:
 2.25"
 5-PIECE DF
 DF Min Height:
 6.5" (with 1.75" Frame)

Species Shown: Rustic Knotty Alder



◀
DORADO
 (1/4" Recessed Panel)
 Min Door Size:
 7" x 7"
 Max Door Size:
 30" x 72"
 Standard Frame:
 2.25"
 5-PIECE DF
 DF Min Height:
 6" (with 1.75" Frame)

Species Shown: Select White Maple



◀
MANCHESTER
 Min Door Size:
 7.5" x 7.5"
 Max Door Size:
 30" x 72"
 Standard Frame:
 2.25"
 5-PIECE DF
 DF Min Height:
 6.5" (with 1.75" Frame)

Species Shown: Select Cherry



◀
DERBY
 Min Door Size:
 7.5" x 7.5"
 Max Door Size:
 30" x 72"
 Standard Frame:
 2.25"
 5-PIECE DF
 DF Min Height:
 6.5" (with 1.75" Frame)

Species Shown: Cherry

WOOD DOORS

WOOD DOORS



▶
EMERALD

Min Door Size:
7.5" x 7.5"

Max Door Size:
30" x 72"

Standard Frame:
2.25"

5-PIECE DF
DF Min Height:
6.5" (with 1.75" Frame)

Species Shown: QTR White Oak



▶
ARIZONA

Min Door Size:
7.5" x 7.5"

Max Door Size:
30" x 72"

Standard Frame:
2.25"

5-PIECE DF
DF Min Height:
6.5" (with 1.75" Frame)

Species Shown: Rift White Oak



▶
FLORENCE

(1/4" Recessed Panel)

Min Door Size:
7" x 7"

Max Door Size:
30" x 72"

Standard Frame:
2.25"

5-PIECE DF
DF Min Height:
5.75" (with 1.75" Frame)

Species Shown: Beech



▶
CM 410

Min Door Size:
8" x 8"

Max Door Size:
30" x 72"

Standard Frame:
2.5"

5-PIECE DF
DF Min Height:
7" (with 2" Frame)

Species Shown: Select Red Oak



◀
MONTE CARLO

Min Door Size:
9" x 9"
Max Door Size:
30" x 72"
Standard Frame:
3"
5-PIECE DF
DF Min Height:
7" (with 2" Frame)

Species Shown: Rift White Oak



◀
BARTON
(1/4" Recessed Panel)

Min Door Size:
8" x 8"
Max Door Size:
30" x 72"
Standard Frame:
3"
5-PIECE DF
DF Min Height:
6.5" (with 2" Frame)

Species Shown: Select Red Oak



◀
BELMONT

Min Door Size:
9" x 9"
Max Door Size:
30" x 72"
Standard Frame:
3"
5-PIECE DF
DF Min Height:
6.5" (with 1.75" Frame)

Species Shown: QTR White Oak



◀
CRESTVIEW
(1/4" Recessed Panel)

Min Door Size:
8" x 8"
Max Door Size:
30" x 72"
Standard Frame:
3"
5-PIECE DF
DF Min Height:
6" (with 1.75" Frame)

Species Shown: Rift White Oak

WOOD DOORS

WOOD DOORS



▶ **AMBER**

(Solid Recessed Panel)

▶ **SANDY**

(1/4" Recessed Panel)

Min Door Size:
7.5" x 7.5"

Max Door Size:
30" x 72"

Standard Frame:
2.5"

5-PIECE DF

DF Min Height:
Amber: 6.5" (1.75" Frame)
Sandy: 6" (1.75" Frame)

Species Shown: Select Hard White Maple



▶ **SUNSET**

(1/4" Recessed Panel)

Min Door Size:
7" x 7"

Max Door Size:
30" x 72"

Standard Frame:
2.5"

5-PIECE DF

DF Min Height:
6" (with 1.75" Frame)

Species Shown: Select Alder



▶ **TANYR**

Min Door Size:
7.5" x 7.5"

Max Door Size:
30" x 72"

Standard Frame:
2.5"

5-PIECE DF

DF Min Height:
6.5" (with 1.75" Frame)

Species Shown: Rustic Knotty Alder



▶ **HEMET**

(1/4" Recessed Panel)

Min Door Size:
7" x 7"

Max Door Size:
30" x 72"

Standard Frame:
2.5"

5-PIECE DF

DF Min Height:
6" (with 1.75" Frame)

Species Shown: Beech



◀
BELLA VISTA
 Min Door Size:
 9" x 9"
 Max Door Size:
 30" x 72"
 Standard Frame:
 3"
 5-PIECE DF
 DF Min Height:
 7" (with 1.875" Frame)

Species Shown: Select Walnut



◀
VISTA
 (1/4" Recessed Panel)
 Min Door Size:
 8" x 8"
 Max Door Size:
 30" x 72"
 Standard Frame:
 3"
 5-PIECE DF
 DF Min Height:
 6" (with 1.875" Frame)

Species Shown: Select Cherry



◀
GEORGIA
 Min Door Size:
 9" x 9"
 Max Door Size:
 30" x 72"
 Standard Frame:
 3"
 5-PIECE DF
 DF Min Height:
 7" (with 2" Frame)

Species Shown: Knotty Alder



◀
ATLANTA
 (1/4" Recessed Panel)
 Min Door Size:
 8" x 8"
 Max Door Size:
 30" x 72"
 Standard Frame:
 3"
 5-PIECE DF
 DF Min Height:
 6.5" (with 2" Frame)

Species Shown: Select Cherry

DOOR PROFILES

WOOD DOORS

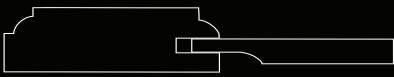

AMBER



ARIZONA



ATLANTA



BOYD



CAMBRIA

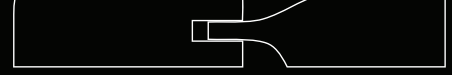

DERBY



CORTINA



CRESTVIEW



DAYTONA



FLORENCE



GARDENIA



GEORGIA



HUNTINGTON



KOPER



LAGUNA



NEWPORT



OGDEN



PANAMA



SAMANTHA



SANDY



SANTA CRUZ



TANYR



VENICE



VISTA

MITERED SERIES



BARTON

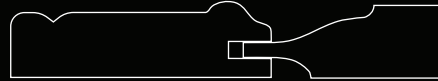

BELLA VISTA

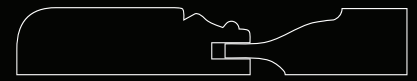

BELMONT



CARMEL



CASTLEWOOD



CM 410



DIPLOMAT



DORADO



EMERALD



GRAHAM

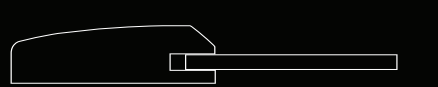

HEMET

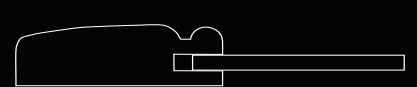

HERMOSA



MANCHESTER



MONTE CARLO



NATHAN



PIPELINE



RANCHO



RIO



SHELBY



SIERRA



SUNSET



WESLEY



WESTON



WINSTON



Featured Door Styles Left to Right: Justin | Carlton | Brock | Alina



MOULDING SERIES

Corona Millworks Moulding Series Wood Doors feature an applied moulding. They are available in a wide range of species and are custom built to your specifications.

Additionally, our wood doors are backed by a 1-Year Limited Warranty.

Due to the unique characteristics of natural wood, there will be variations in grain and color on your finished product.

WOOD DOORS

WOOD DOORS



▶
CARLTON

Min Door Size:
9" x 9"

Max Door Size:
30" x 72"

Standard Frame:
2.25"

5-PIECE DF
DF Min Height:
7.5" (with 1.5" Rails)

Species Shown: Knotty Alder



▶
SHERIDON
(1/4" Recessed Panel)

Min Door Size:
7.5" x 7.5"

Max Door Size:
30" x 72"

Standard Frame:
2.25"

5-PIECE DF
DF Min Height:
7" (with 1.5" Rails)

Species Shown: Beech



▶
JACKSON
(1/4" Recessed Panel)

Min Door Size:
8" x 8"

Max Door Size:
30" x 72"

Standard Frame:
2.5"

5-PIECE DF
DF Min Height:
6" (with 1.5" Rails)

Species Shown: Select Cherry



▶
HORIZON
(Solid Recessed Panel)

Min Door Size:
8" x 8"

Max Door Size:
30" x 72"

Standard Frame:
2.5"

5-PIECE DF
DF Min Height:
6" (with 1.5" Rails)

Species Shown: QTR White Oak



◀
ALINA
 (1/4" Recessed Panel)
 Min Door Size:
 8" x 8"
 Max Door Size:
 30" x 72"
 Standard Frame:
 2.5"
 5-PIECE DF
 DF Min Height:
 6" (with 1.5" Rails)

Species Shown: Select Hard White Maple



◀
STRAGER
 Min Door Size:
 9.5" x 9.5"
 Max Door Size:
 30" x 72"
 Standard Frame:
 2.5"
 5-PIECE DF
 DF Min Height:
 7.5" (with 1.5" Rails)

Species Shown: African Mahogany



◀
CASCADE
 (1/4" Recessed Panel)
 Min Door Size:
 7.5" x 7.5"
 Max Door Size:
 30" x 72"
 Standard Frame:
 2.5"
 5-PIECE DF
 DF Min Height:
 6" (with 1.5" Rails)

Species Shown: Select Hard White Maple



◀
SARA
 Min Door Size:
 11" x 11"
 Max Door Size:
 30" x 72"
 Standard Frame:
 3"
 5-PIECE DF
 DF Min Height:
 7.75" (with 1.5" Rails)

Species Shown: Select Alder

WOOD DOORS

WOOD DOORS



▶
ZORN

Min Door Size:
11" x 11"
Max Door Size:
30" x 72"
Standard Frame:
3"
5-PIECE DF
DF Min Height:
8" (with 1.5" Rails)

Species Shown: Select Red Oak



▶
JANE

(1/4" Recessed Panel)
Min Door Size:
8.5" x 8.5"
Max Door Size:
30" x 72"
Standard Frame:
3"
5-PIECE DF
DF Min Height:
7.5" (with 1.5" Rails)

Species Shown: Select Alder



▶
MLD 446

Min Door Size:
10" x 10"
Max Door Size:
30" x 72"
Standard Frame:
2.5"
5-PIECE DF
DF Min Height:
8.5" (with 1.75" Rails)

Species Shown: Knotty Alder



▶
JUSTIN

Min Door Size:
10.75" x 10.75"
Max Door Size:
30" x 72"
Standard Frame:
3"
5-PIECE DF
DF Min Height:
8.5" (with 1.75" Frame)

Species Shown: Select Hard White Maple

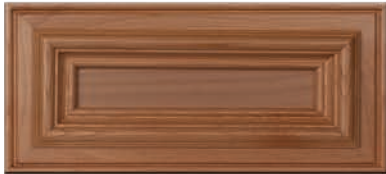

◀
CHEYENNE
 (1/4" Recessed Panel)
 Min Door Size:
 9" x 9"
 Max Door Size:
 30" x 72"
 Standard Frame:
 3"
 5-PIECE DF
 DF Min Height:
 7.5" (with 1.75" Frame)

Species Shown: Select Alder



◀
MLD 33
 Min Door Size:
 10" x 10"
 Max Door Size:
 30" x 72"
 Standard Frame:
 2.5"
 5-PIECE DF
 DF Min Height:
 8" (with 1.5" Rails)

Species Shown: Select Hard White Maple



◀
BROCK
 Min Door Size:
 9" x 9"
 Max Door Size:
 30" x 72"
 Standard Frame:
 3"
 5-PIECE DF
 DF Min Height:
 7.5" (with 2.25" Frame)

Species Shown: Select Cherry



◀
HARRISON
 (1/4" Recessed Panel)
 Min Door Size:
 8.5" x 8.5"
 Max Door Size:
 30" x 72"
 Standard Frame:
 3"
 5-PIECE DF
 DF Min Height:
 6.5" (with 2.25" Frame)

Species Shown: Select Red Oak

MOULDING SERIES

WOOD DOORS



►
MELBOURNE
Min Door Size:
9" x 9"
Max Door Size:
30" x 72"
Standard Frame:
3"
5-PIECE DF
DF Min Height:
7" (with 2" Frame)

Species Shown: Select Hard White Maple



►
RAYA
(1/4" Recessed Panel)
Min Door Size:
7" x 7"
Max Door Size:
30" x 72"
Standard Frame:
2.5"
5-PIECE DF
DF Min Height:
6" (with 1.75" Frame)

Species Shown: Select Cherry



►
PINNACLE
Min Door Size:
8" x 8"
Max Door Size:
30" x 72"
Standard Frame:
2.5"
5-PIECE DF
DF Min Height:
6.5" (with 1.75" Frame)

Species Shown: Select Cherry

DOOR PROFILES



ALINA



BROCK



CARLTON

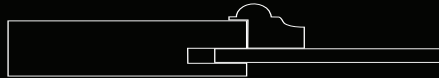

CASCADE



CHEYENNE



HARRISON



HORIZON



JACKSON



JANE



JUSTIN

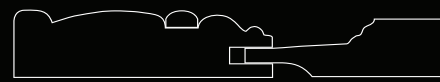

MELBOURNE



MLD 33



MLD 446



PINNACLE



RAYA



SARA



SHERIDON



STRAGER



ZORN



Featured Door Styles Left to Right: French Lite Door | Savannah | European | Donovan



CONTEMPORARY SERIES LOUVER SERIES SPECIALTY OPTIONS

Contemporary Series Wood Doors from Corona Millworks are available in several unique styles. From solid slab, to louver, to radius, we offer several options to help complete a multitude of design needs.

Additionally, our wood doors are backed by a 1-Year Limited Warranty.

Due to the unique characteristics of natural wood, there will be variations in grain and color on your finished product.

CONTEMPORARY SERIES

WOOD DOORS



▶ EUROPEAN

Min Door Size:
7.5" x 8"

Max Door Size:
30" x 72"

5-PIECE DF
DF Min Height:
6" (with 1.5" Rails)

Species Shown: Select Walnut



▶ AMSTERDAM

Min Door Size:
6" x 9"

Max Door Size:
30" x 72"

5-PIECE DF
DF Min Height:
6.5" (with 1.5" Rails)

Species Shown: Select Hard White Maple



▶ SAVANNAH (With Battens)

Min Door Size:
8" x 9"

Max Door Size:
30" x 72"

SLAB DF
3.5"

Species Shown: Beech



EUROPEAN

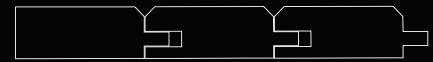

AMSTERDAM

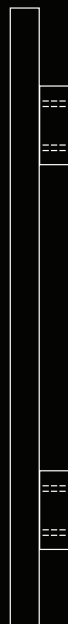

◀ SAVANNAH (Side View)



▲ SAVANNAH (Top View)

LOUVER SERIES

WOOD DOORS



Species Shown: Knotty Alder

◀ **DONOVAN**
(True Louver)
Min Door Size:
8.5" x 8.5"
Max Door Size:
20" x 48"
Frame Width:
2.5"
5-PIECE DF
DF Min Height:
6" (with 1.5" Rails)



Species Shown: Select Red Oak

◀ **EASTON**
Min Door Size:
8.5" x 8.5"
Max Door Size:
30" x 72"
Frame Width:
2.5"
SLAB DF
3.5"

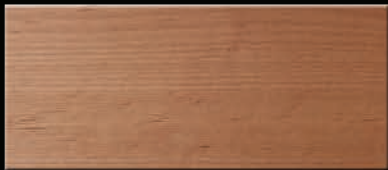

Species Shown: Select Alder

◀ **CABRILLO**
Min Door Size:
8.5" x 8.5"
Max Door Size:
30" x 72"
Frame Width:
2.5"
SLAB DF
3.5"



DONOVAN



EASTON

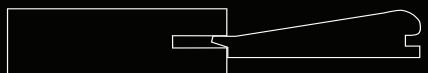

CABRILLO

SPECIALTY OPTIONS

WOOD DOORS



▲ **RADIUS FRAME DOOR**
Species Shown: Select Cherry



▲ **EYEBROW ARCH DOORS**
Species Shown: Select Red Oak



▲ **ANGLE DOOR**
Species Shown: Select Hard White Maple



▲ **HALF CIRCLE ARCH DOOR**
Species Shown: Select Walnut



▲ OUTER FRAME EYEBROW DOORS WITH 7 FRENCH LITES
Species Shown: Select Hard White Maple



▲ GLASS DOOR 9 MARGIN LITES
Species Shown: Select Red Oak



▲ GLASS DOOR 4 LITES
Species Shown: Select Hard White Maple



FINGER PULLS

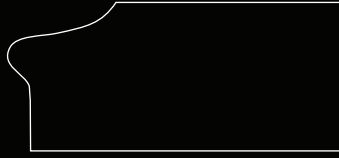

OD-1
ASTRON FP



OD-4
3/8" BULLNOSE FP



OD-7
3/8" STEP BULLNOSE FP



OD-10
ULTRA FP



OD-13
1/8" BULLNOSE FP



OD-16
1/4" BULLNOSE FP

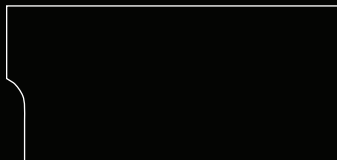

OD-18
SQUARE FP



OD-19
LAGUNA FP



OD-21
30 DEGREE BACK BEVEL

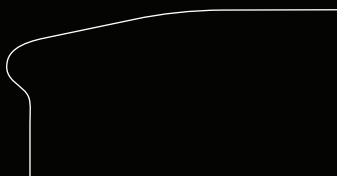

OD-27
HUNTINGTON FP

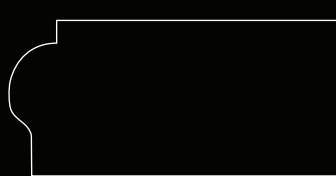

OD-29
1/4" STEP BULLNOSE FP

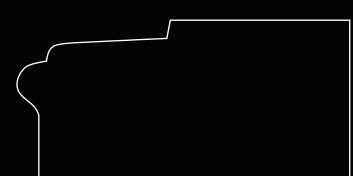

OD-241
ALL PRO SMALL FP

EDGE DETAIL OPTIONS

WOOD DOORS

NO-LIP PULLS

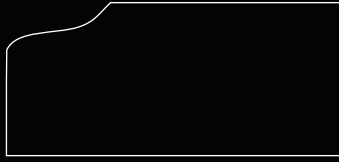

OD-2
ASTRON NL

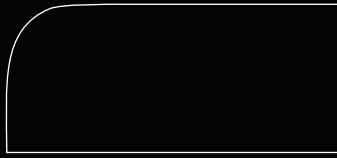

OD-5
3/8" BULLNOSE NL

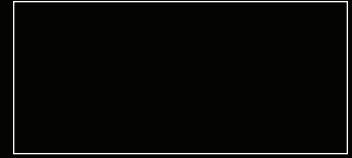

OD-6
SQUARE NL



OD-8
3/8" STEP BULLNOSE NL



OD-9
SAN CLEMENTE NL



OD-11
ULTRA NL

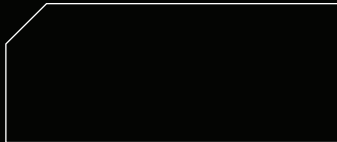

OD-12
ALEXIS NL

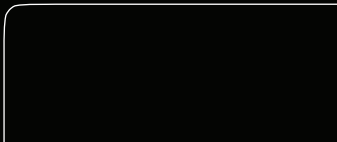

OD-14
1/8" BULLNOSE NL



OD-15
HUNTINGTON NL

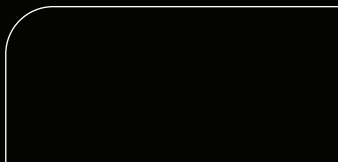

OD-17
1/4" BULLNOSE NL



OD-20
LAGUNA NL

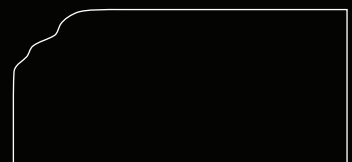

OD-22
MONTE CARLO NL

EDGE DETAIL OPTIONS

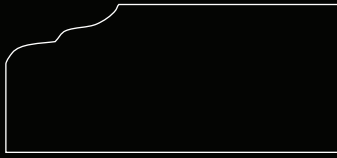

OD-23
JULIAN NL

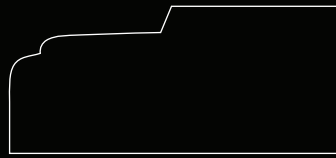

OD-24
ALL PRO BIG NL



OD-25
ROMA NL



OD-26
PUFFY NL



OD-28
ROSEWOOD NL
Option Fee Applies

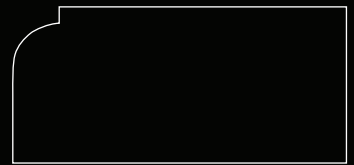

OD-30
1/4" STEP BULLNOSE NL

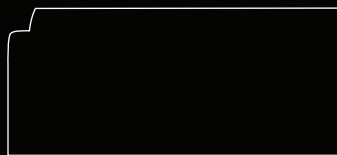

OD-40
HANOVER NL

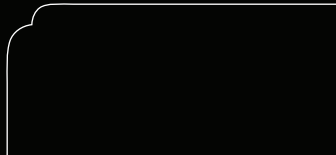

OD-63
TROY NL



OD-270
CHAMBERLAIN NL

LIPPED PULL

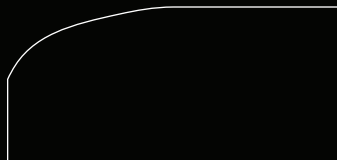

OD-364
SANTA ROSA NL

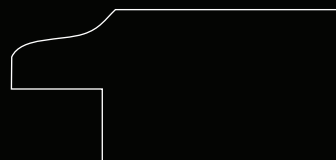

OD-3
ASTRON LP
Lip Pull Option





E-SERIES

VENEER TEXTURED MELAMINE HIGH GLOSS ACRYLIC HIGH PRESSURE LAMINATE

E-Series cabinet doors from Corona Millworks offer European trend-setting design by providing a more streamlined look. Our E-Series doors are offered in Veneer, Textured Melamine, High Pressure Laminate (HPL), and High-Gloss Acrylic. Additionally, our E-Series doors are backed by a 1-Year Limited Warranty.

Due to the nature of the printing process, colors depicted may vary when compared to your finished product.

E-SERIES

E-SERIES



V-050-H

(Horizontal Panel Grain)

V-050-V

(Vertical Panel Grain)

VENEER

Slab with 0.5mm Edgeband

Color Shown: Alder



V-100-H

(Horizontal Panel Grain)

V-100-V

(Vertical Panel Grain)

VENEER

Slab with 1mm Edgeband

Color Shown: Plain Sliced Red Oak

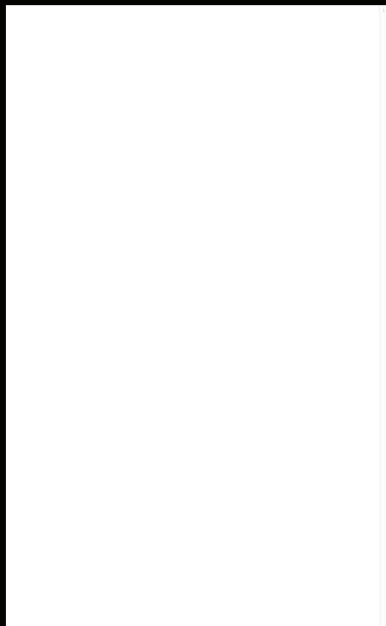

A-100-H

(Horizontal Panel Grain)

A-100-V

(Vertical Panel Grain)

ULTRA HIGH GLOSS
ACRYLIC

Slab with 1mm Edgeband

Color Shown: Arctic



A-300-H

(Horizontal Panel Grain)

A-300-V

(Vertical Panel Grain)

ULTRA HIGH GLOSS
ACRYLIC

3-Piece with 1mm Edgeband

Color Shown: Sienna Teak

DOORS & DRAWER FACES

E-SERIES



◀
V-300-H
 (Horizontal Panel Grain)
V-300-V
 (Vertical Panel Grain)
VENEER
 Slab with 3mm Edgeband

Color Shown: Plain Sliced Maple

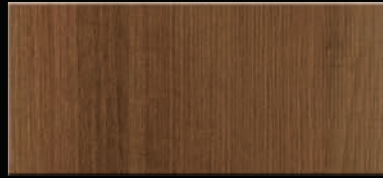

◀
TM-100-H
 (Horizontal Panel Grain)
TM-100-V
 (Vertical Panel Grain)
**HIGH DEFINITION
 TEXTURED MELAMINE**
 Slab with 1mm Edgeband
 Shown with optional grain match

Color Shown: Summit



◀
TM-300-H
 (Horizontal Panel Grain)
TM-300-V
 (Vertical Panel Grain)
**HIGH DEFINITION
 TEXTURED MELAMINE**
 3-Piece with 1mm Edgeband

Color Shown: Aspen



◀
TM-500-H
 (Horizontal Panel Grain)
TM-500-V
 (Vertical Panel Grain)
**HIGH DEFINITION
 TEXTURED MELAMINE**
 5-Piece with 1mm Edgeband
 DF shown is TM-100-H

Color Shown: Vail

E-SERIES COLOR OPTIONS

STOCK TEXTURED MELAMINE

ROÜCKEHD

E-SERIES



ALOE



ASPEN



BASALT



CORTEZ

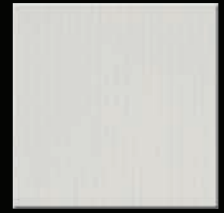

DESIGNER WHITE



DURANGO

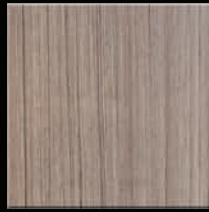

SILVERTON



SLATE



SUMMIT



VAIL

STOCK ACRYLIC

StyleLite®



ARCTIC
(ALSO AVAILABLE IN
LOW GLOSS VELVET FINISH)

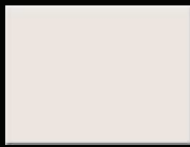

ALABASTER

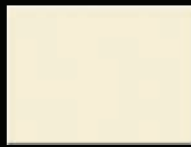

SIERRA



SAND



CHAMPAGNE
(METALLIC)

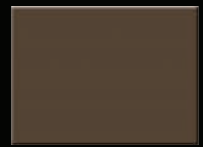

MOCHA

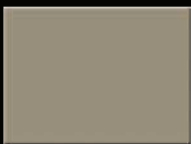

ASH

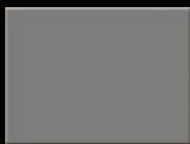

SILVER
(METALLIC)

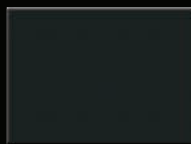

SLATE

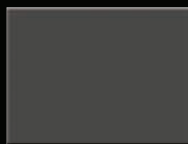

GRAPHITE
(METALLIC)

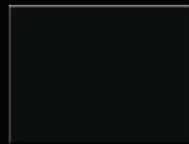

CARBON



CHERRY



RUBY



RIGA BIRCH



LAVATO OAK



SIENNA TEAK



TULIPWOOD

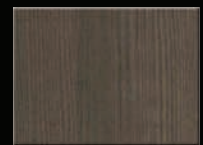

TIERRA ELM

Additional Textured Melamine, Acrylic, and High-Pressure Laminates are available. Please contact Customer Service for more information.

E-SERIES SIZE & MATERIAL SPECS

E-SERIES

TM-100
A-100

Slab with
1mm Edgeband

SIZING

Minimum Height: 3"
Minimum Width: 10"

VERTICAL GRAIN

Maximum Height: 96"
Maximum Width: 48"

HORIZONTAL GRAIN

Maximum Height: 48"
Maximum Width: 96"

STOCK MATERIAL

Panel Thickness: 3/4"
Core: Particle Board

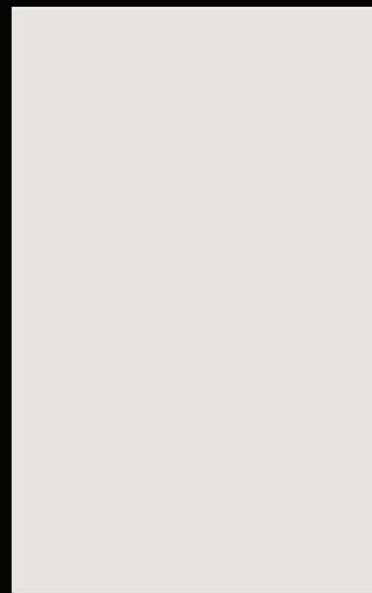

TM-300
A-300

3-Piece with
1mm Edgeband

SPECIFICATIONS

Minimum Height: 3"
Minimum Width: 10"
Maximum Height: 48"
Maximum Width: 48"

STOCK MATERIAL

Frame Thickness: 3/4"
Panel Thickness: 3/4"
Core: Particle Board



3" | 3"

TM-500

5-Piece with
1mm Edgeband

SPECIFICATIONS

Minimum Height: 10"
Minimum Width: 10"
Maximum Height: 48" (without center rail)
96" (with center rail)
Maximum Width: 48"

STOCK MATERIAL

Frame Thickness: 3/4"
Panel Thickness: 1/4"
Core: Particle Board



3"

3"

Additional Textured Melamine, Acrylic, and High-Pressure Laminates are available.

Please contact customer service for more information and available options.

MELAMINE SLAB DOORS:
M-050 (.5mm Edgeband)
M-100 (1mm Edgeband)
M-300 (3mm Edgeband)

LAMINATE SLAB DOORS:
L-050 (.5mm Edgeband)
L-100 (1mm Edgeband)
L-300 (3mm Edgeband)



Featured Door Styles Left to Right: CM783 | CM782 | CM742 | CM400



THERMOFOIL SERIES

Corona Millworks Thermofoil Series Doors are uniform in color and are a great alternative to stained or painted wood doors.

Additionally, our Thermofoil Doors are backed by a 5-Year Limited Warranty.

Due to the nature of the printing process, colors depicted may vary when compared to your finished product.

THERMOFOIL SERIES



▶
CM 63
Min Door Size:
8.5" x 8.5"
Max Door Size:
36" x 72"
ROUTED DF
Min DF Height:
8.5"

Color Shown: Latitude South



▶
CM 69
Min Door Size:
8" x 8"
Max Door Size:
36" x 72"
ROUTED DF
Min DF Height:
5.5"

Color Shown: Acajou Mahogany



▶
CM 100
Min Door Size:
7" x 7"
Max Door Size:
36" x 72"
SOLID DF
Min DF Height:
3.5"

Color Shown: Charcoal Portuna



▶
CM 131
Min Door Size:
8" x 8"
Max Door Size:
36" x 72"
SOLID DF
Min DF Height:
3.5"

Color Shown: Classic Cherry

THERMOFOIL

DOORS & DRAWER FACES



◀
CM 181
Min Door Size:
8" x 8"
Max Door Size:
36" x 72"
ROUTED DF
Min DF Height:
5.5"

Color Shown: Realistic Walnut



◀
CM 182
Min Door Size:
8" x 8"
Max Door Size:
36" x 72"
ROUTED DF
Min DF Height:
5.5"

Color Shown: CM Wenge



◀
CM 300
Min Door Size:
8" x 8"
Max Door Size:
36" x 72"
ROUTED DF
Min DF Height:
5.5"

Color Shown: Almond



◀
CM 400
Min Door Size:
9" x 9"
Max Door Size:
36" x 72"
ROUTED DF
Min DF Height:
7.5"

Color Shown: Milk Chocolate

THERMOFOIL

THERMOFOIL SERIES



▶
CM 500

Min Door Size:
8" x 8"

Max Door Size:
36" x 72"

ROUTED DF
Min DF Height:
5.5"

Color Shown: Summer Flame



▶
CM 527

Min Door Size:
9.5" x 9.5"

Max Door Size:
36" x 72"

ROUTED DF
Min DF Height:
7"

Color Shown: Satin White

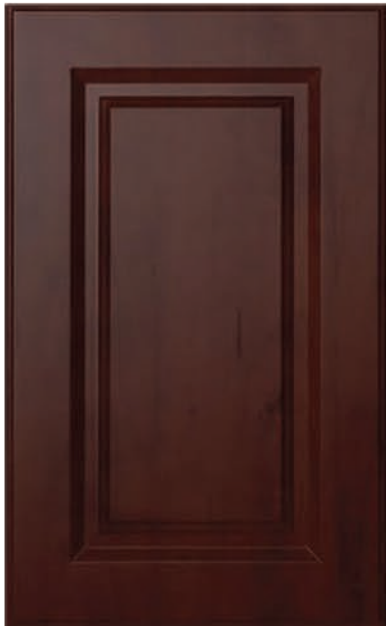
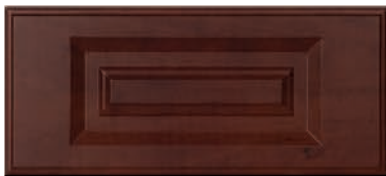

▶
CM 530

Min Door Size:
8" x 8"

Max Door Size:
36" x 72"

ROUTED DF
Min DF Height:
6.5"

Color Shown: Summer Flame



▶
CM 540

Min Door Size:
8" x 8"

Max Door Size:
36" x 72"

ROUTED DF
Min DF Height:
6"

Color Shown: Secret

THERMOFOIL

DOORS & DRAWER FACES



◀
CM 570
Min Door Size:
8" x 8"
Max Door Size:
36" x 72"
ROUTED DF
Min DF Height:
5.5"

Color Shown: Hardrock Maple



◀
CM 700
Min Door Size:
8" x 8"
Max Door Size:
36" x 72"
ROUTED DF
Min DF Height:
6.125"

Color Shown: Chocolate Pear



◀
CM 712
Min Door Size:
8" x 8"
Max Door Size:
36" x 72"
ROUTED DF
Min DF Height:
5.5"

Color Shown: Antique White



◀
CM 714
Min Door Size:
10.5" x 10"
Max Door Size:
36" x 72"
SOLID DF
Min DF Height:
3.5"

Color Shown: Cherry Pear

THERMOFOIL

THERMOFOIL SERIES



▶
CM 716

Min Door Size:
9" x 10"

Max Door Size:
36" x 72"

SOLID DF
Min DF Height:
3.5"

Color Shown: Classic Cherry



▶
CM 722

Min Door Size:
8" x 8"

Max Door Size:
36" x 72"

ROUTED DF
Min DF Height:
5.5"

Color Shown: Hardrock Maple



▶
CM 731

Min Door Size:
8" x 8"

Max Door Size:
36" x 72"

ROUTED DF
Min DF Height:
5.5"

Color Shown: Latitude North



▶
CM 732

Min Door Size:
7" x 7"

Max Door Size:
36" x 72"

ROUTED DF
Min DF Height:
3.5"

Color Shown: Brushed Aluminum

THERMOFOIL

DOORS & DRAWER FACES



◀
CM 742
Min Door Size:
8" x 8"
Max Door Size:
36" x 72"
ROUTED DF
Min DF Height:
5.5"

Color Shown: Summer Flame



◀
CM 744
Min Door Size:
10.5" x 10"
Max Door Size:
36" x 72"
SOLID DF
Min DF Height:
3.5"

Color Shown: Realistic Walnut

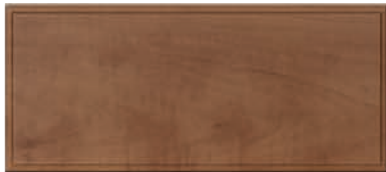

◀
CM 746
Min Door Size:
9" x 10"
Max Door Size:
36" x 72"
SOLID DF
Min DF Height:
3.5"

Color Shown: Candlelight



◀
CM 756
Min Door Size:
8" x 8"
Max Door Size:
36" x 72"
ROUTED DF
Min DF Height:
5.5"

Color Shown: CM 949 White

THERMOFOIL

THERMOFOIL SERIES

THERMOFOIL



▶
CM 757
Min Door Size:
10.5" x 10"
Max Door Size:
36" x 72"
SOLID DF
Min DF Height:
3.5"

Color Shown: Cherry Blossom



▶
CM 758
Min Door Size:
9" x 10"
Max Door Size:
36" x 72"
SOLID DF
Min DF Height:
3.5"

Color Shown: Blonde Maple



▶
CM 766
Min Door Size:
8" x 8"
Max Door Size:
36" x 72"
ROUTED DF
Min DF Height:
5.5"

Color Shown: Fashion Grey



▶
CM 767
Min Door Size:
10.5" x 10"
Max Door Size:
36" x 72"
SOLID DF
Min DF Height:
3.5"

Color Shown: Secret

DOORS & DRAWER FACES



◀
CM 768
Min Door Size:
9" x 10"
Max Door Size:
36" x 72"
SOLID DF
Min DF Height:
3.5"

Color Shown: Chocolate Pear



◀
CM 775
Min Door Size:
10.5" x 10"
Max Door Size:
36" x 72"
SOLID DF
Min DF Height:
3.5"

Color Shown: Cherry Blossom



◀
CM 776
Min Door Size:
9.5" x 10"
Max Door Size:
36" x 72"
SOLID DF
Min DF Height:
3.5"

Color Shown: Uniboard Sandbank



◀
CM 777
Min Door Size:
8" x 8"
Max Door Size:
36" x 72"
ROUTED DF
Min DF Height:
5.5"

Color Shown: Candlelight

THERMOFOIL

THERMOFOIL SERIES



▶
CM 782
Min Door Size:
10.5" x 10"
Max Door Size:
36" x 72"
SOLID DF
Min DF Height:
3.5"

Color Shown: Queenston Oak



▶
CM 783
Min Door Size:
9.5" x 10"
Max Door Size:
36" x 72"
SOLID DF
Min DF Height:
3.5"

Color Shown: Italian Woodline Wenge



▶
CM 785
Min Door Size:
8" x 8"
Max Door Size:
36" x 72"
ROUTED DF
Min DF Height:
5.5"

Color Shown: Walnut Amati



▶
CM 800
Min Door Size:
8" x 8"
Max Door Size:
36" x 72"
ROUTED DF
Min DF Height:
5.5"

Color Shown: Dark Chocolate

THERMOFOIL

DOORS & DRAWER FACES



Color Shown: Anigre

◀
CM 807
Min Door Size:
9" x 9"
Max Door Size:
36" x 72"
ROUTED DF
Min DF Height:
7.5"



Color Shown: Latitude East

◀
CM 810
Min Door Size:
9" x 9"
Max Door Size:
36" x 72"
ROUTED DF
Min DF Height:
7.5"



Color Shown: White Woodgrain

◀
CM 819
Min Door Size:
8" x 8"
Max Door Size:
36" x 72"
ROUTED DF
Min DF Height:
6"



Color Shown: Latitude West

◀
CM 842
Min Door Size:
8" x 8"
Max Door Size:
36" x 72"
ROUTED DF
Min DF Height:
5.5"

THERMOFOIL

THERMOFOIL SERIES



►
CM 844
Min Door Size:
10.5" x 10"
Max Door Size:
36" x 72"
SOLID DF
Min DF Height:
3.5"

Color Shown: Summer Breeze



►
CM 846
Min Door Size:
9.5" x 10"
Max Door Size:
36" x 72"
SOLID DF
Min DF Height:
3.5"

Color Shown: Acajou Mahogany



►
CM 877
Min Door Size:
8" x 8"
Max Door Size:
36" x 72"
ROUTED DF
Min DF Height:
5.5"

Color Shown: Realistic Walnut



►
CM 942
Min Door Size:
8" x 8"
Max Door Size:
36" x 72"
ROUTED DF
Min DF Height:
5.5"

Color Shown: Almond

THERMOFOIL

DOORS & DRAWER FACES



◀
CM 944
Min Door Size:
10.5" x 10"
Max Door Size:
36" x 72"
SOLID DF
Min DF Height:
3.5"

Color Shown: Hardrock Maple Light



◀
CM 946
Min Door Size:
9.5" x 10"
Max Door Size:
36" x 72"
SOLID DF
Min DF Height:
3.5"

Color Shown: Charcoal Portuna



◀
CM 977
Min Door Size:
8.5" x 8.5"
Max Door Size:
36" x 72"
ROUTED DF
Min DF Height:
7"

Color Shown: Classic Cherry



◀
CM 979
Min Door Size:
9.5" x 10"
Max Door Size:
36" x 72"
SOLID DF
Min DF Height:
3.5"

Color Shown: Cherry Pear

THERMOFOIL

THERMOFOIL SERIES



▶
CM 980

Min Door Size:
7" x 7"

Max Door Size:
36" x 72"

ROUTED DF
Min DF Height:
5.5"

Color Shown: Cherry Blossom



▶
CM 981

Min Door Size:
10.5" x 10"

Max Door Size:
36" x 72"

SOLID DF
Min DF Height:
3.5"

Color Shown: Wenge



▶
CM 982

Min Door Size:
9.5" x 10"

Max Door Size:
36" x 72"

SOLID DF
Min DF Height:
3.5"

Color Shown: Anigre



▶
CM 1210

Min Door Size:
8" x 8"

Max Door Size:
36" x 72"

ROUTED DF
Min DF Height:
5.5"

Color Shown: Mission White

THERMOFOIL

DOORS & DRAWER FACES



Color Shown: Hardrock Maple

◀
CM 1220
Min Door Size:
9.5" x 10"
Max Door Size:
36" x 72"
SOLID DF
Min DF Height:
3.5"



Color Shown: Windsor Mahogany

◀
CM 1230
Min Door Size:
10.5" x 10"
Max Door Size:
36" x 72"
SOLID DF
Min DF Height:
3.5"



Color Shown: Latitude North

◀
CM 1345
Min Door Size:
8" x 8"
Max Door Size:
36" x 72"
ROUTED DF
Min DF Height:
5.5"



Color Shown: Snow White

◀
CM 2210
Min Door Size:
8" x 8"
Max Door Size:
36" x 72"
ROUTED DF
Min DF Height:
5.5"

THERMOFOIL

THERMOFOIL SERIES



▶
CM 2220
Min Door Size:
9.5" x 10"
Max Door Size:
36" x 72"
SOLID DF
Min DF Height:
3.5"

Color Shown: Natural Maple



▶
CM 2230
Min Door Size:
10.5" x 10"
Max Door Size:
36" x 72"
SOLID DF
Min DF Height:
3.5"

Color Shown: Latitude South

THERMOFOIL

FINGER PULL OPTIONS

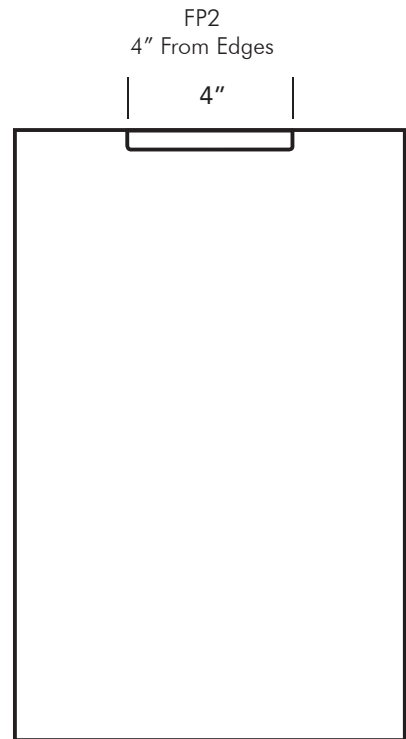
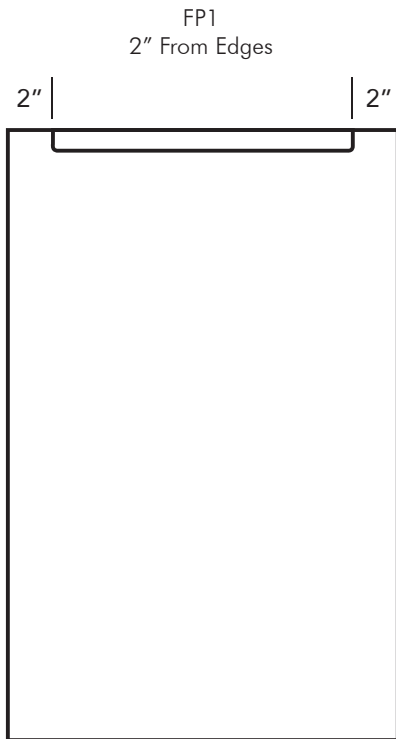

THERMOFOIL EDGE DETAIL



EDGE DETAIL CF 2

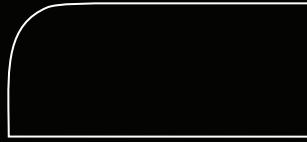

EDGE DETAIL CF 5



EDGE DETAIL CF 6



EDGE DETAIL CF 14

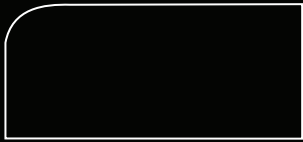

EDGE DETAIL CF 17



EDGE DETAIL CF 20



EDGE DETAIL CF 24/400

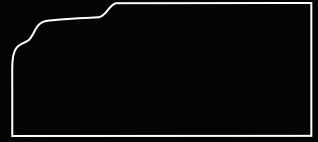

EDGE DETAIL CF 150

THERMOFOIL

AVAILABLE MOULDING OPTIONS

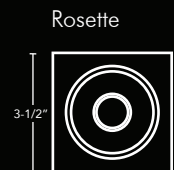
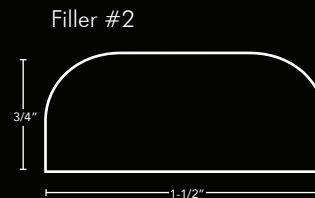
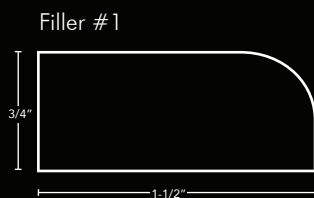
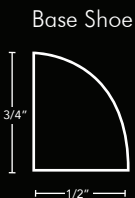
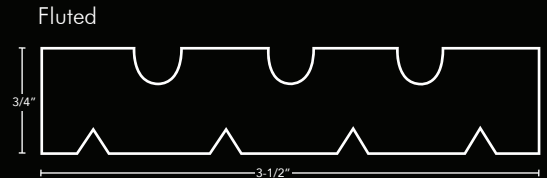
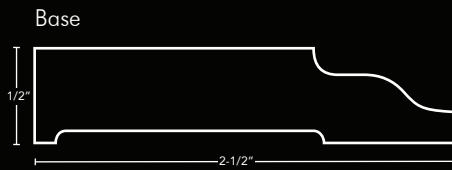
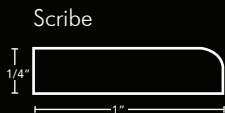
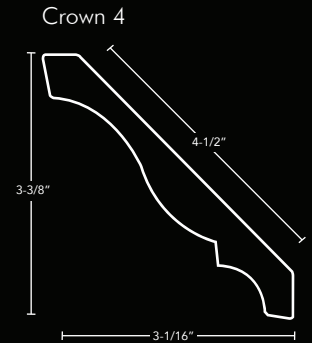
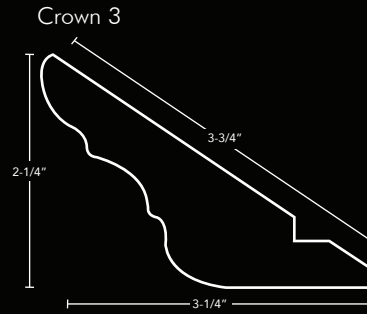
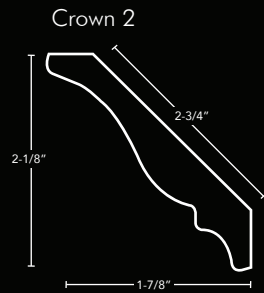
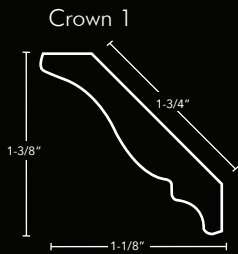

THERMOFOIL SERIES



CM 63



CM 69



CM 100



CM 300



CM 400



CM 500

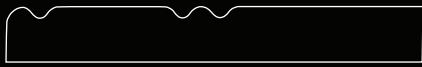

CM 570



CM 700



CM 712 / CM 714 / CM 716



CM 742 / CM 744 / CM 746



CM 756 / CM 757 / CM 758



CM 766 / CM 767 / CM 768



CM 807



CM 810



CM 819



CM 977



CM 979



CM 980 / CM 981 / CM 982

THERMOFOIL

DOOR PROFILES

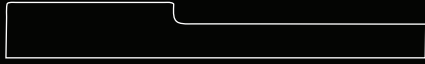

CM 131



CM 181



CM 182



CM 527



CM 530



CM 540



CM 722



CM 731

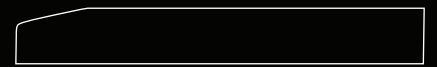

CM 732



CM 775 / CM 767 / CM 777



CM 782 / CM 783 / CM 785



CM 800



CM 842 / CM 844 / CM 846



CM 877



CM 942 / CM 944 / CM 946



CM 1210 / CM 1220 / CM 1230



CM 1345



CM 2210 / CM 2220 / CM 2230

THERMOFOIL



Cabinet Doors, Drawer Boxes
and Cabinet Components

**Corona Thermo Foil
Color Options**

Order Line
909-606-3288
800-200-0975

Fax: 909-606-3270

5572 Edison Ave
Chino, CA 91710

THERMOFOIL COLOR OPTIONS



ACAJOU MAHOGANY



ALMOND



ANIGRE



ANTIQUE WHITE



BLONDE MAPLE



BRUSHED ALUMINUM

THERMOFOIL



CANDLELIGHT



CHARCOAL PORTUNA



CHERRY BLOSSOM

THERMOFOIL COLOR OPTIONS



CHERRY PEAR

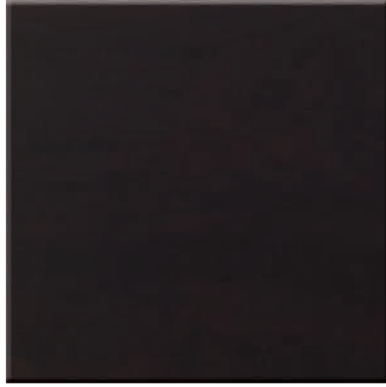

CHOCOLATE PEAR



CLASSIC CHERRY

THERMOFOIL



CM 949 WHITE



CM WENGE



DARK CHOCOLATE



FASHION GREY



HARDROCK MAPLE



HARDROCK MAPLE LITE

THERMOFOIL COLOR OPTIONS



HIGH GLOSS WHITE



ITALIAN WOODLINE WENGE



LATTITUDE EAST



LATTITUDE NORTH



LATTITUDE SOUTH



LATTITUDE WEST



MILK CHOCOLATE



MISSION WHITE



NATURAL MAPLE

THERMOFOIL

THERMOFOIL COLOR OPTIONS



QUEENSTON OAK



REALISTIC WALNUT



SATIN WHITE

THERMOFOIL



SECRET



SNOW WHITE



SUMMER BREEZE



SUMMER FLAME



UNIBOARD SANDBANK



WALNUT AMATI

THERMOFOIL COLOR OPTIONS



WENGE



WHITE WOODGRAIN

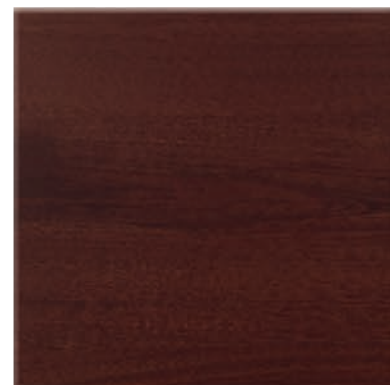

WINDSOR MAHOGANY



THERMOFOIL





DRAWER BOXES & CUSTOM INSERTS

Corona Millworks Drawer Boxes are available in a wide range of materials and construction options. Each drawer box is hand crafted to your exact specifications. Our friendly customer service representatives can provide complete information on all construction and materials options including solid wood, plywoods, availability, and pricing.

Due to the unique characteristics of natural wood, there will be variations in grain and color on your finished product.

DRAWER BOXES



◀ **SCALLOPED SIDES**
scoops optional

▼ **DOVETAIL CONSTRUCTION**



◀ **ANGLED SIDES**
scoops optional

▼ **DOWEL CONSTRUCTION**



◀ **NOTCH, DRILL & CLIPS**

- Notch & Drill for Corona Slides and other top name brands
- Drawer Slides available in 15", 18", and 21"
- Concealed under-mount
- Full-extension
- Soft-close
- Maximum static capacity: 100 lbs
- Maximum dynamic capacity: 75 lbs

SCOOP OPTIONS

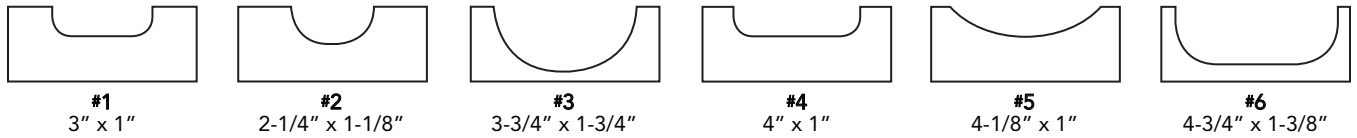

SIDE MATERIALS

Finished & Unfinished

Plywood

- 1/2" or 5/8" Baltic Birch
- 1/2" or 5/8" Europly Maple

Solid Wood

- 1/2" or 5/8" Maple (Soft)
- 1/2" or 5/8" Maple (Select White)
- 1/2" or 5/8" Alder
- 1/2" or 5/8" Aspen
- 1/2" or 5/8" Beech
- 1/2" or 5/8" Cherry
- 1/2" or 5/8" Oak (Red)

*All solid material finished after assembly

Melamine

- 1/2" or 5/8" White Melamine
- 1/2" Maple Melamine
- 1/2" Black Melamine
- 1/2" Almond Melamine
- 1/2" White Melamine (w/MDF Core)

*Available in doweled construction only

BOTTOM MATERIALS

Finished & Unfinished

- 1/4" or 1/2" in:
Maple, Birch, Cherry, Alder, Red Oak, Beech

Melamine

- 1/4" or 1/2" White Melamine
- 1/4" or 1/2" Maple Melamine
- 1/4" or 1/2" Black Melamine
- 1/4" or 1/2" Almond Melamine

TOP EDGES

- Bull Nose
- Square
- Square Flush

TOP FINISHES

- Clear Foil
- PVC Tape
- Wood Tape

Additional and special order drawer box materials are available. Please contact customer service for more information.



▲ LASER ENGRAVING

Leave a lasting impression of your craftsmanship for the lifetime of the kitchen. Provide your company's logo artwork and our production department will handle the rest. Laser Logos are available on most of our boxes and materials.



5-7 DAY LEAD TIME

CUSTOM WOOD BOXES & INSERTS



PULL-OUT TRASH BINS ▲

- Single Bin (35 qt.) and Double Bin (70 qt.)
- Pre-finished 9-ply birch
- Beautiful dovetail construction
- Door attaches to front of box
- Notch & Drilled ready to install
- BLUM Soft Close under-mount guides included
- Rubbermaid trash bins included

DRAWER BOXES



◀ CORNER BOXES

- 1/2", 5/8", 3/4" (standard wood species)
- Available in doweled or nailed construction
- Dividers come standard and are removable, specify vertical or horizontal
- Depth is measured from front to end of side
- Notch & Drill available for under-mount hardware

SILVERWARE & UTENSIL INSERTS ►

- Available in doweled or dovetailed construction
- Four configurations available
- Order inserts installed or removable
- 3/8" thick and 1-1/2" tall, pre-finished maple



CUSTOM WOOD BOXES & INSERTS



SPICE PULL-OUT BOXES ▲

- Beautiful dovetail construction
- Available in any standard wood species
- Unfinished or pre-finished
- Built to your specs
- Maximum height is 21"
- Middle shelf is adjustable and removable
- Each shelf's bottom is recessed 1/2"
- Top and bottom shelf height is 3"
- Middle shelf height is 2"



SPICE DRAWER BOX WITH INSERT ▼

- Available in doweled or nailed construction
- Available in any standard wood species
- Inserts are a combination of 1/2" fronts and 1/4" bottoms, pre-finished maple ply
- Depth of box determines number of steps
- Suggested height: 3-1/2", or can build to specs



◀ FILE BOXES

- 1/2", 5/8", 3/4" (Standard wood species)
- Available in standard (letter) and lateral (legal) style (bars run either width or depth of box)
- 9-3/8" minimum inside height
- 13-1/4" minimum inside width (letter)
- 16-1/4" minimum inside width (legal)
- Hanging bars are optional, must be specified
- Slots for bars: 1/8" wide, 1" high
- Slots generally located 3/8" from sides/back or front of drawer

DRAWER BOXES

UNDER SINK STORAGE ▶

- Beautiful dovetail construction
- Available in 9-ply birch or 9-ply maple
- Standard height is 12" or can build to specs
- Top and bottom shelf height is 3"
- Bottoms recessed 1/2"
- Install either using side-mount or under-mount hardware
- Use for kitchen and bath applications





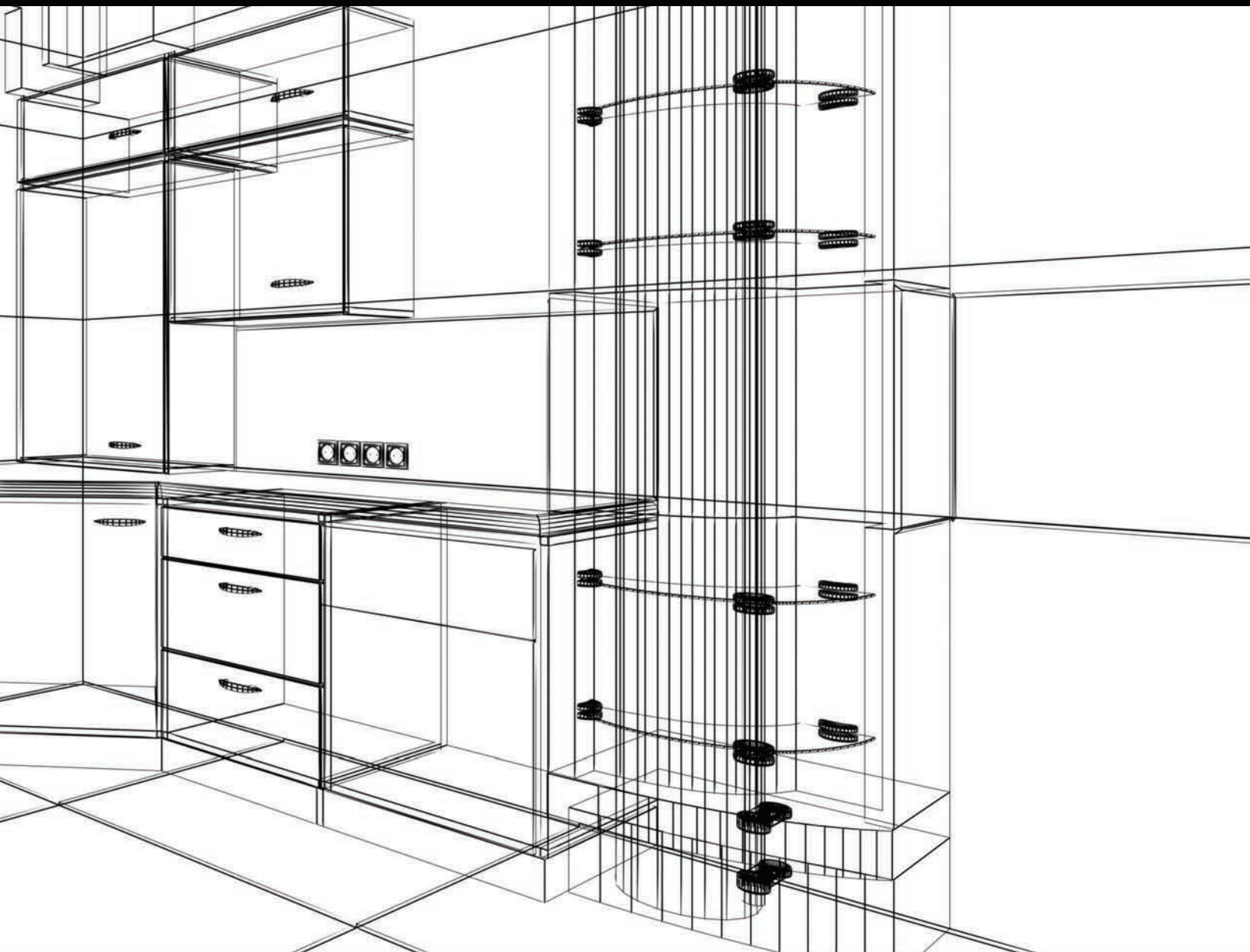

CABINET COMPONENTS & PARTS

Corona Millworks utilizes Cabinet Vision software and CNC equipment for cabinet component manufacturing. With this technology, we can efficiently produce cabinet parts with no standard or stock sizes. Every component is custom produced per-order and is shipped ready to assemble.

Our CNC capabilities allow us to precision machine a wide variety of cabinet components for the cabinet industry. Simply provide the dimensions, material specifications, and quantities. We'll handle the rest!

COMPONENT INFORMATION & GUIDELINES

CABINET CONSTRUCTION

1. All parts are 3/4" thick except back. The customer specifies materials used.
2. Dowel Screws (confirmat) are used primarily for assembly. Provided by Corona Millworks.
3. Finished ends can be dowel constructed, or a 3/4" applied finished end can be fabricated from the exterior material. Applied door panels are also available. Corona Millworks will provide inserted hardwood dowels in all horizontal cabinet components for doweled cabinet assembly.
4. Backs are 1/4" thick and dadoed on the sides and bottom of the cabinet. Stop dadoes are used on wall-hung cabinet sides.
5. Drawer stretchers are placed relative to the size and location of the drawer front.
6. Nailers are placed behind the back and are cut from off-fall material. Color may vary.
7. Construction methods may vary for customers' specific requests and option fees will apply.

HARDWARE HOLE LAYOUT METHODS

CNC Machining System

All hardware holes are accurately machined. Holes are placed specifically for each hinge plate, drawer slide, and adjustable shelves.

Holes required for hinge baseplates are placed relative to the top and bottom of the door. Hinge cups can be bored 3" from the top and bottom edge of the door.

Drawer hardware holes are placed for the specified hardware and relative to location of the drawer.

Adjustable shelf holes are placed between the base plates only if adjustable shelves are specified in the cabinet.

Specify exactly which hardware applications are to be used when placing order. Only hardware called out on the order form will fit on the final machined part.

CNC MACHINING CENTER SYSTEM

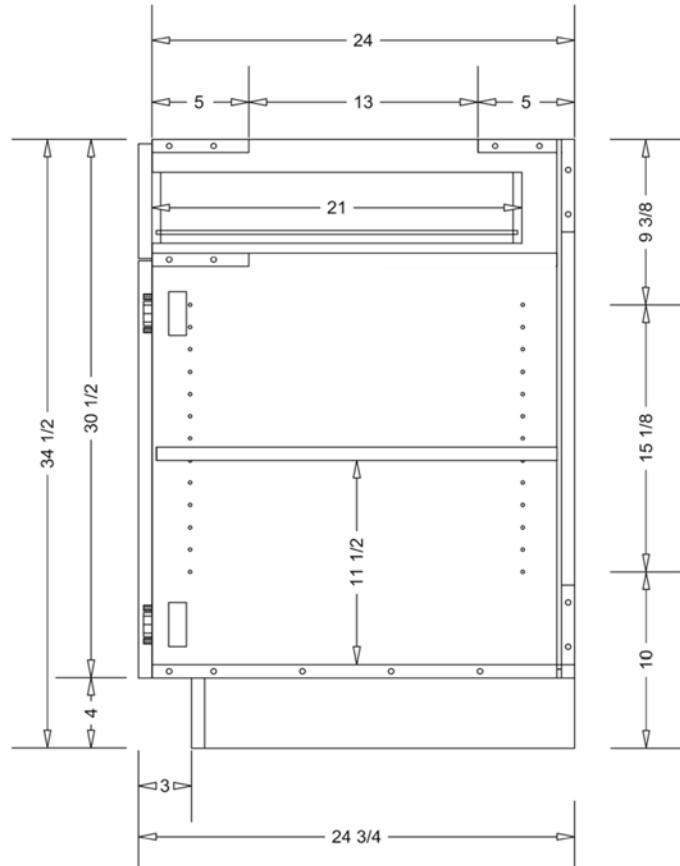

CABINETRY DETAIL ILLUSTRATED

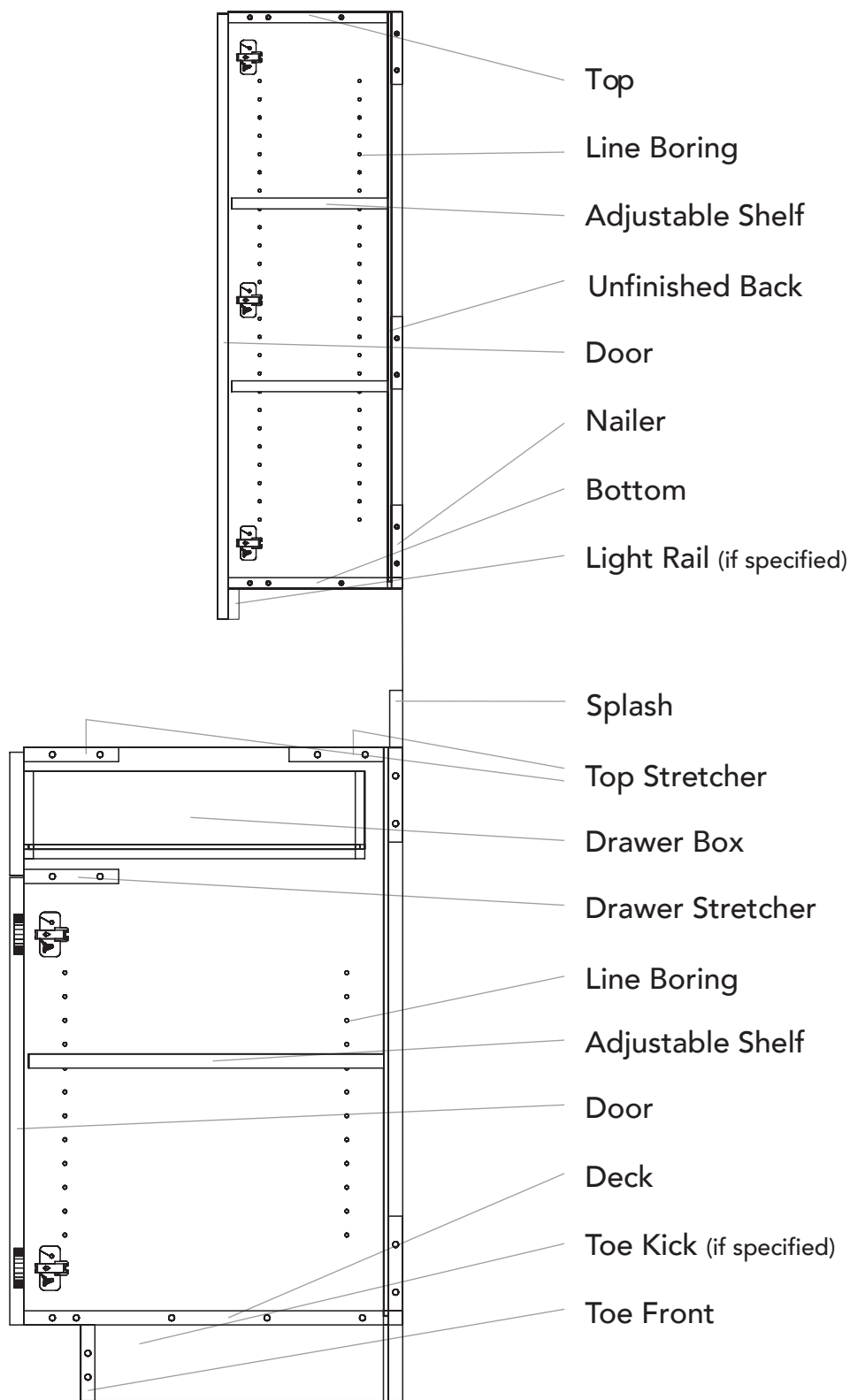

- Top
- Line Boring
- Adjustable Shelf
- Unfinished Back
- Door
- Nailer
- Bottom
- Light Rail (if specified)
- Splash
- Top Stretcher
- Drawer Box
- Drawer Stretcher
- Line Boring
- Adjustable Shelf
- Door
- Deck
- Toe Kick (if specified)
- Toe Front

COMPONENTS

Corona Millworks can construct the cabinet to meet all Woodwork Institute construction standards. It is the responsibility of the customer to specify correct materials, to meet specific grade requirements, and to certify Woodwork Institute compliance.

COMPONENTS & PARTS

100 SERIES - Base Cabinets

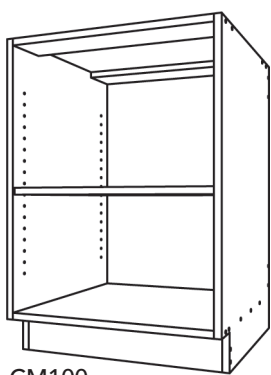

CM100

Open Base Cabinet

- Specify type and number of shelves on order form
- Interior surface shall be as listed on order form unless noted differently

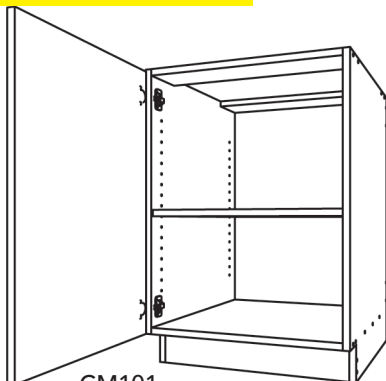

CM101

Open Door Base Cabinet

- Specify type and number of shelves on order form

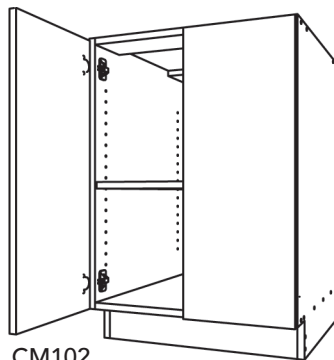

CM102

Two-Door Base Cabinet

- Specify type and number of shelves on order form

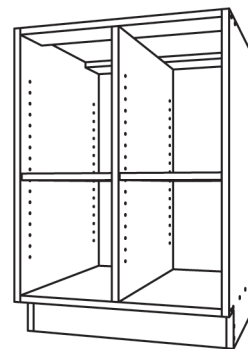

CM110

Open Base Cabinet - One Vertical Divider

- Specify type and number of shelves per opening on order form
- Interior surface shall be as listed on order form unless noted differently

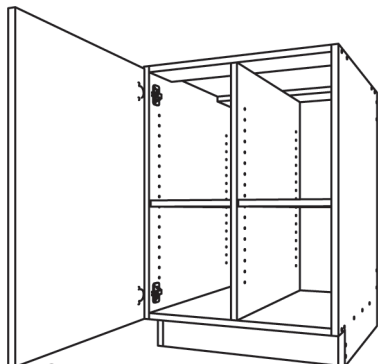

CM111

One-Door Base Cabinet - One Vertical Divider

- Specify type and number of shelves per opening on order form

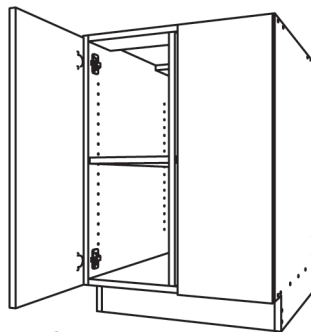

CM112

Two-Door Base Cabinet - One Vertical Divider

- Specify type and number of shelves per opening on order form

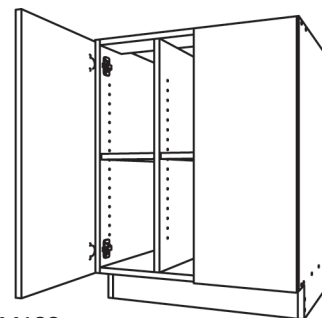

CM122

Two-Door Base Cabinet - Two Vertical Dividers

- Specify type and number of shelves per opening on order form

140 SERIES - Base Cabinets

Cabinet with 4 1/2" apron inset in cabinet.

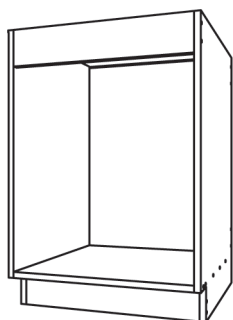

CM140

Open Base Cabinet

- 4 1/2" Apron
- Interior surface shall be as listed on order form unless noted differently

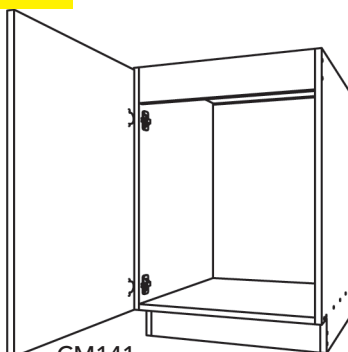

CM141

One Door Base Cabinet

- 4 1/2" Apron behind door

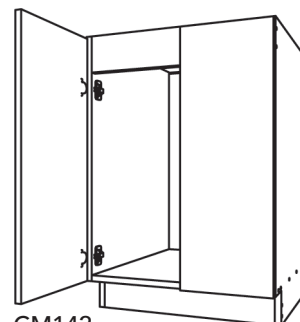

CM142

Two Door Base Cabinet

- 4 1/2" Apron behind door

100 SERIES - Base Cabinets

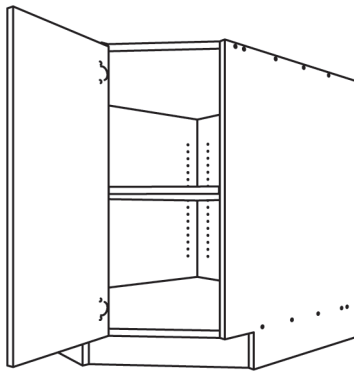

CM186
Two-Door at 45° Angle Corner Base Cabinet

- Specify type and number of shelves on order form
- * Note: Constructed with 3/4" back

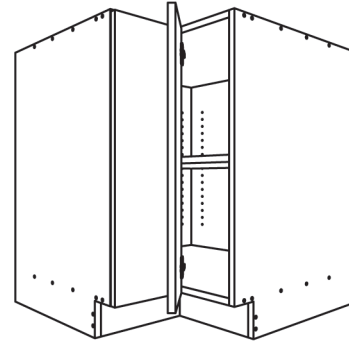

CM197
Two-Door Corner Base Cabinet

- Doors are hinged left or right and bi-fold in the center
- Lazy Susan - must specify diameter and material

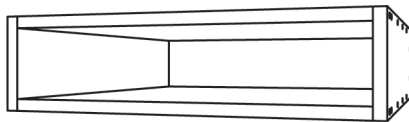

CM190
Storage Apron

- Interior surface shall be as listed on order form unless noted differently

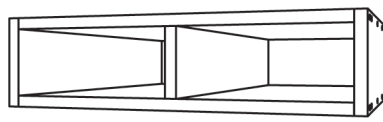

CM191
Storage Apron - One Vertical Divider

- Two equal openings
- Interior surface shall be as listed on order form unless noted differently

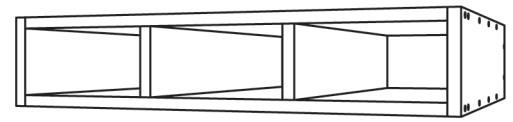

CM192
Storage Apron - Two Vertical Dividers

- Three equal openings
- Interior surface shall be as listed on order form unless noted differently

Sink cabinet with false drawer front. No top stretchers and a vertical false front backer is placed behind the false front.

150 SERIES - Base Cabinets

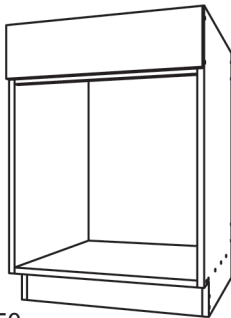

CM150
Open Base Cabinet - False Front

- Specify false front height
- Interior surface shall be as listed on order form unless noted differently
- Apron behind FF and hangs 1" lower

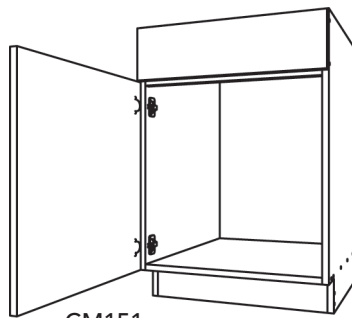

CM151
One-Door Base Cabinet - False Front

- Specify false front height
- Apron behind FF and hangs 1/2" lower

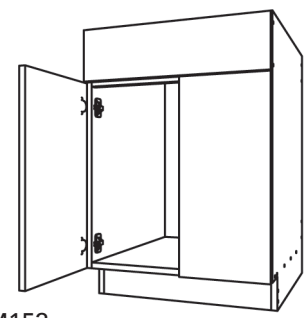

CM152
Two-Door Base Cabinet - False Front

- Specify false front height
- Apron behind FF and hangs 1/2" lower

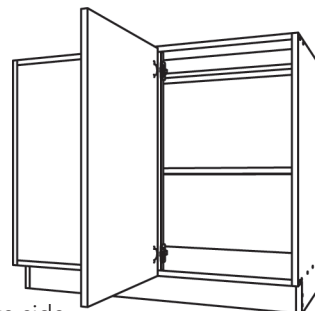

CM176
One-Door Corner Base Cabinet - False Panel

- Specify type and number of shelves on order form
- Specify width of false front panel
- Specify hinge right or left for false panel on opposite side

Note: Hinged on false panel with face frame hinges.

- Lazy Susan hardware is not included unless specified on order form.
- Specify left or right side, width and height dimensions for return panel.

COMPONENTS & PARTS

200 SERIES - Base Cabinets with Drawers

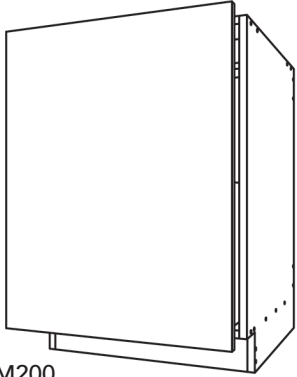

CM200
One-Drawer Base Cabinet

- Full height drawer

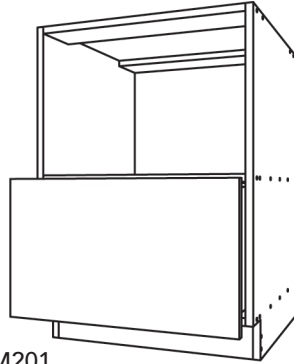

CM201
One-Drawer Open Base Cabinet

- Specify opening height
- Interior surface shall be as listed on order form unless noted differently

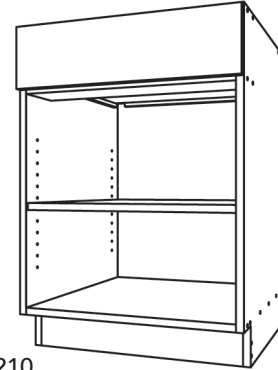

CM210
One-Drawer Open Base Cabinet

- Specify opening height
- Interior surface shall be as listed on order form unless noted differently

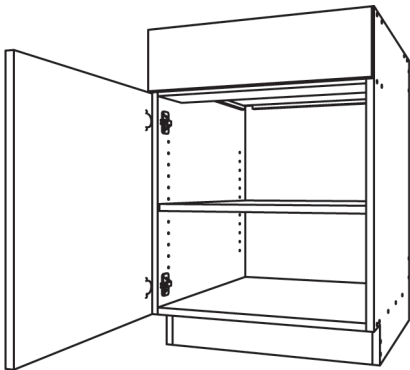

CM211
One-Drawer Open Base Cabinet

- Specify opening height
- Interior surface shall be as listed on order form unless noted differently

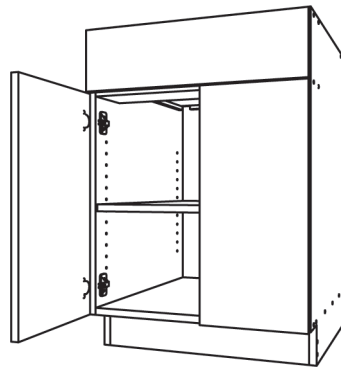

CM212
Two-Door Base Cabinet

- One Wide Drawer
- Specify type and number of shelves on order form

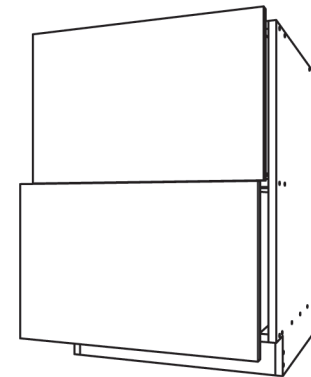

CM220
Two-Drawer Base Cabinet

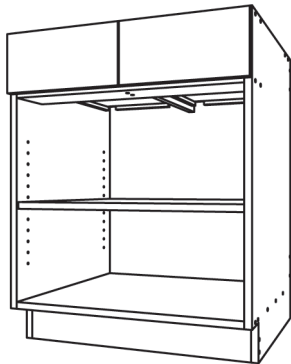

CM221
Open Wide Base Cabinet - Two-Drawer

- Specify type and number of shelves per opening on order form
- Interior surface shall be as listed on order form unless noted differently
- Comes standard with vertical drawer partitions

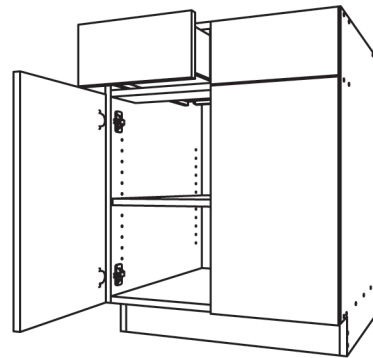

CM222
Two-Door Base Cabinet - Two-Drawer

- Specify type and number of shelves per opening on order form

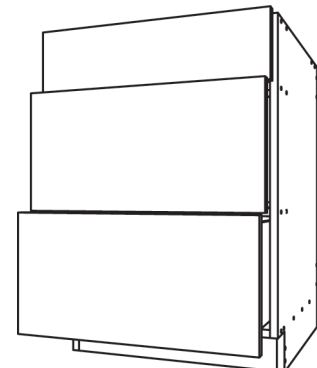

CM230
Three-Drawer Base Cabinet

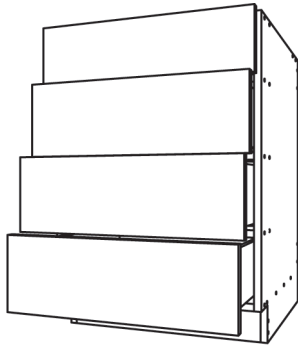

CM240
Four-Drawer Base Cabinet

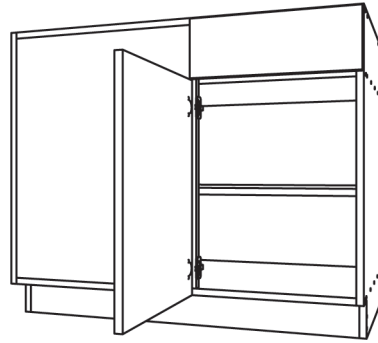

CM276
One-Door Corner Base Cabinet - One Drawer

- Specify type and number of shelves on order form
- Specify width of false front panel

Note: Hinged on false panel with face frame hinges.

- Specify drawer front heights.
- Door and drawer fronts must equal the height of cabinet including the top and bottom reveals with 1/8" (3mm) gap between drawers.

Built with no bottoms.

200 SERIES - Drawer Aprons



CM290
One-Drawer Apron

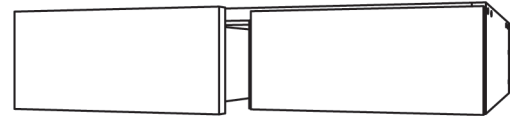

CM291
Two Equal-Drawer Apron

Wall cabinets made of interior material unless specified.

300 SERIES - Upper Cabinets

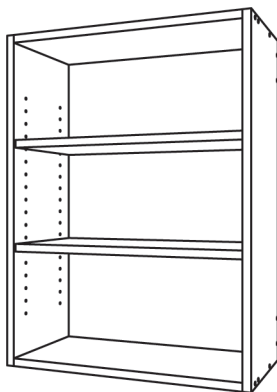

CM300
Open Upper Cabinet

- Specify type and number of shelves on order form
- Interior surface shall be as listed on order form unless noted differently

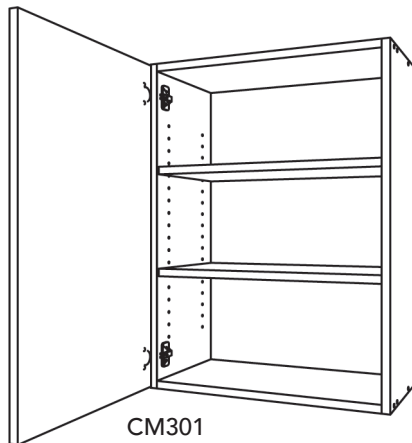

CM301
One-Door Upper Cabinet

- Specify type and number of shelves on order form

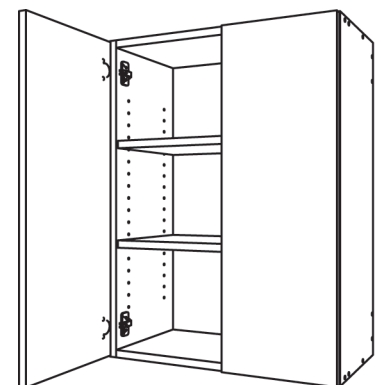

CM302
Two-Door Upper Cabinet

- Specify type and number of shelves on order form
- Interior surface shall be as listed on order form unless noted differently

COMPONENTS & PARTS

300 SERIES - Upper Cabinets

Wall cabinets made of interior material unless specified.

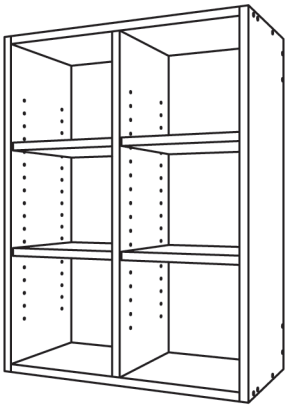

CM310

Open Upper Cabinet

- One vertical divider
- Specify type and number of shelves per opening on order form
- Interior surface shall be listed on order form unless noted differently

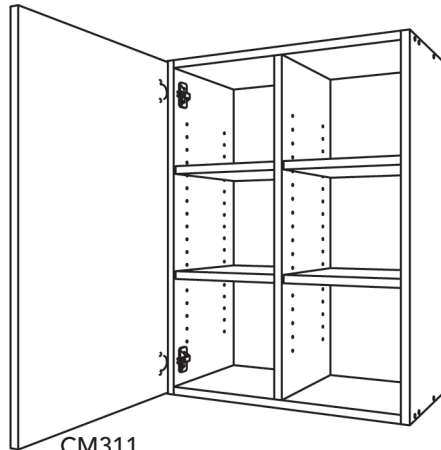

CM311

One-Door Upper Cabinet

- One vertical divider
- Specify type and number of shelves per opening on order form

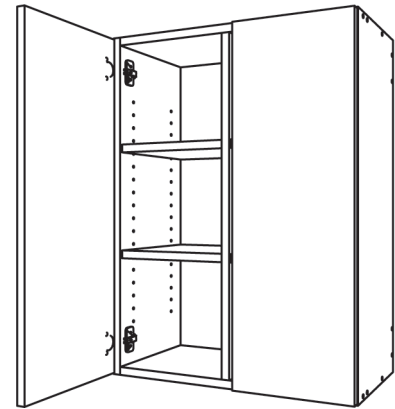

CM312

Two-Door Upper Cabinet

- One vertical divider
- Specify type and number of shelves per opening on order form

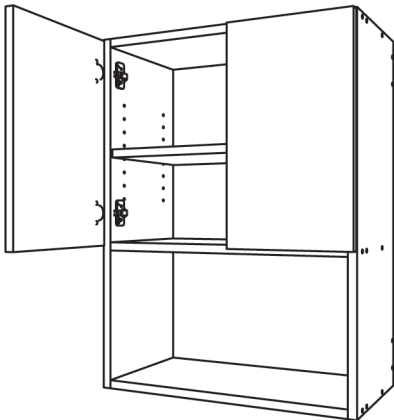

CM326

Partial Open Upper Cabinet - Two Doors

- Specify inside clear height of bottom opening

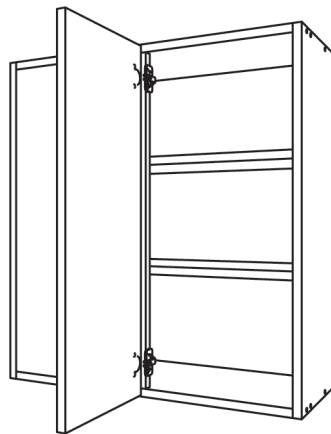

CM376 (Blind Corner 1)

One-Door Corner Upper Cabinet with False Panel

- Specify type and number of shelves per opening on order form
- Specify width of false panel
- Specify hinge right or left for false panel on opposite side

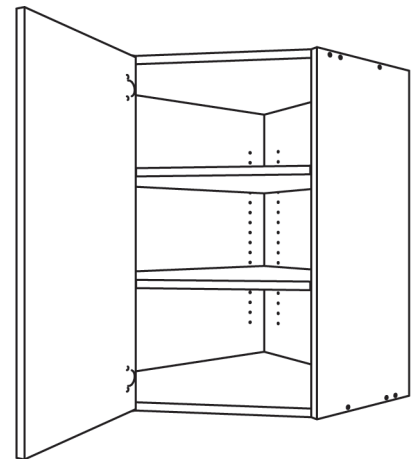

CM386 (Angle Corner 2)

One-Door at 45° Angle Corner Upper Cabinet

- Specify type and number of shelves per opening on order form

COMPONENTS

- Corner cabinets are constructed with 3/4" backs.

(L-Shaped 2) **CM397**

Two-Door Upper Corner Cabinet

- Doors are hinged left or right and bi-fold in the center
- Specify type and number of shelves on order form

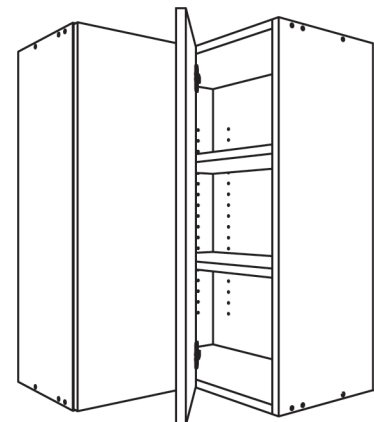

400 SERIES - Tall Cabinets

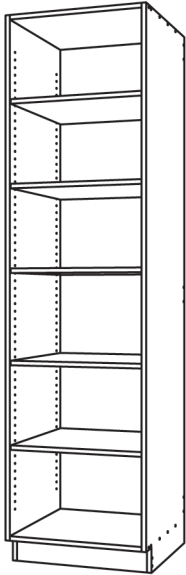

CM400

Open Tall Cabinet

- Specify type and number of shelves on order form
- Interior surface shall be as listed on order form unless noted differently

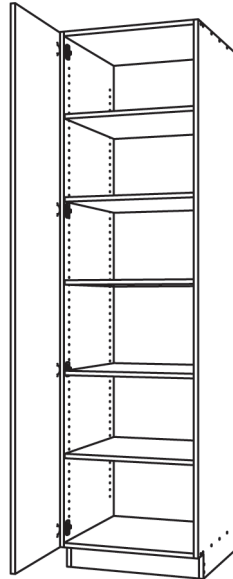

CM401

Open-Door Tall Cabinet

- Specify type and number of shelves on order form

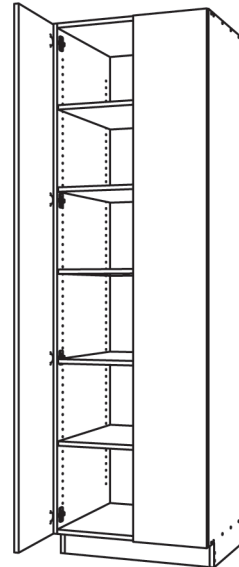

CM402

Two-Door Tall Cabinet

- Specify type and number of shelves on order form

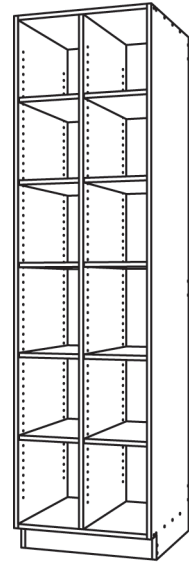

CM410

Open Tall Cabinet

- Open vertical divider
- Specify type and number of shelves on order form
- Interior surface shall be as listed on order form unless noted differently

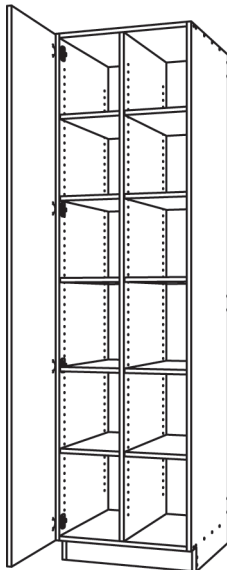

CM411

One-Door Tall Cabinet

- One vertical divider
- Specify type and number of shelves on order form

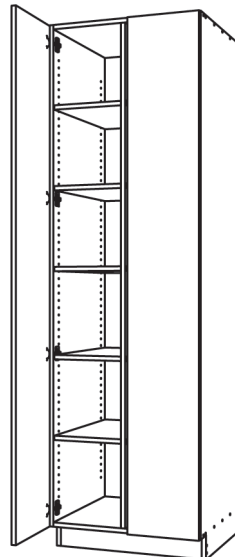

CM412

Two-Door Tall Cabinet

- One vertical divider
- Specify type and number of shelves on order form

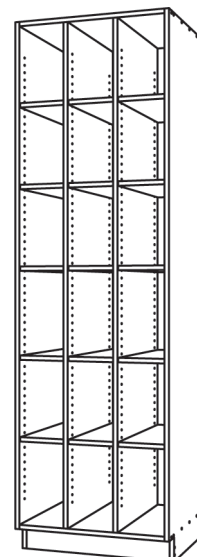

CM420

Open Tall Cabinet

- Two vertical dividers
- Specify type and number of shelves on order form
- Interior surface shall be as listed on order form unless noted differently

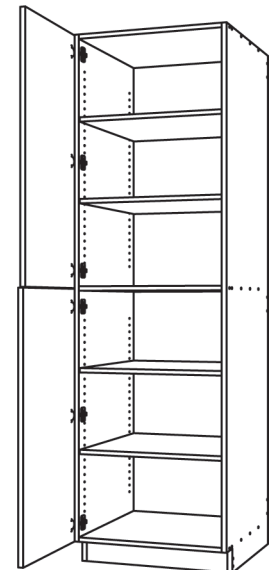

CM423

Two-Door Tall Cabinet

- Specify type and number of shelves on order form
- Specify inside clear opening height on top section

COMPONENTS & PARTS

400 SERIES - Tall Cabinets

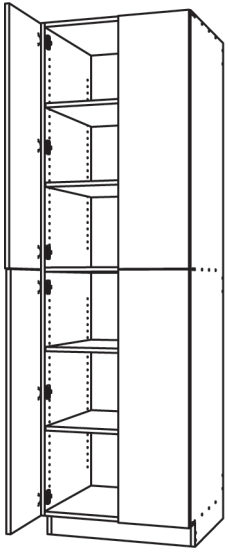

CM424
Tall Cabinet - Four Doors
- Split Height

- Specify door heights
- Specify type and number of shelves on order form

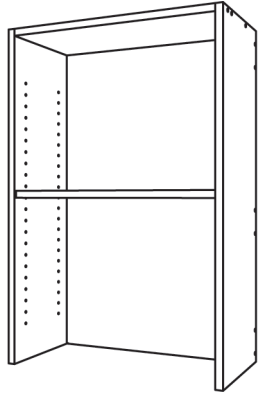

CM440
Open Hutch Cabinet

- Specify number of adjustable shelves
- Interior surface shall be as listed on order form unless noted differently

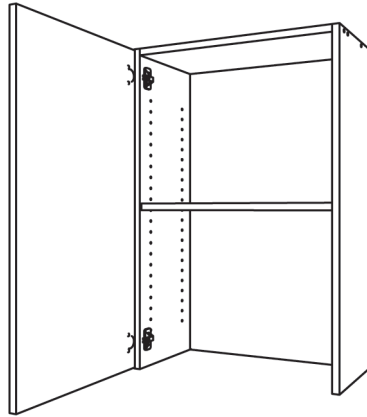

CM441
One-Door Hutch Cabinet

- Specify number of adjustable shelves
- Interior surface shall be as listed on order form unless noted differently

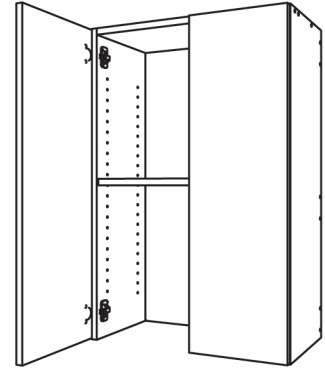

CM442
Two-Door Hutch Cabinet

- Specify number of adjustable shelves
- Interior surface shall be as listed on order form unless noted differently

800 SERIES - Tall Cabinets

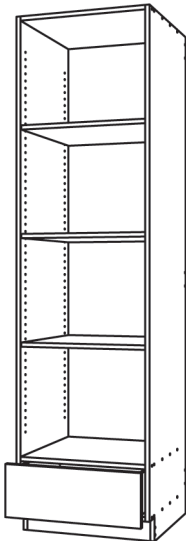

CM810
Open Tall Cabinet - One Drawer

- One Fixed shelf standard
- Specify drawer front height
- Specify number of adjustable shelves
- Interior surface shall be as listed on order form unless noted differently

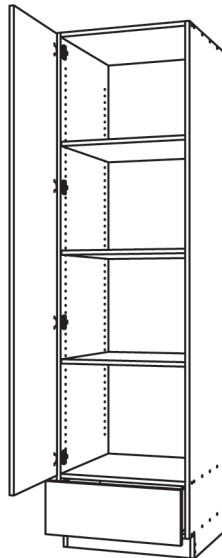

CM811
One-Door Tall Cabinet - One Drawer

- One fixed shelf standard
- Specify drawer front height
- Specify number of adjustable shelves

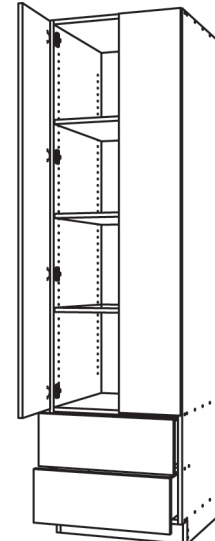

CM820
Two-Door Tall Cabinet - Two Drawers

- 1 Fixed shelf standard
- Specify drawer front heights
- Specify number of adjustable shelves

Specialty Cabinets

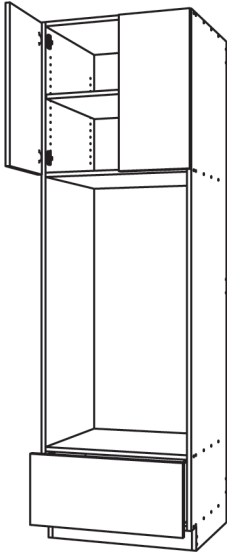

- CM812 - O**
Tall Cabinet for Oven - Two Doors
- Specify height for drawer front
 - Specify inside clear opening height
 - Specify type and number of shelves on order form

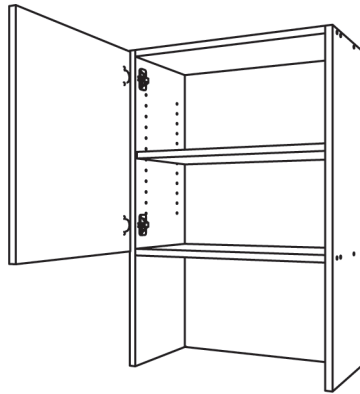

- CM441 - O**
One Opening Hutch Cabinet - One Door
- One fixed shelf standard
 - Specify opening height
 - Specify number of adjustable shelves
 - Interior surface shall be as listed on order form unless noted differently

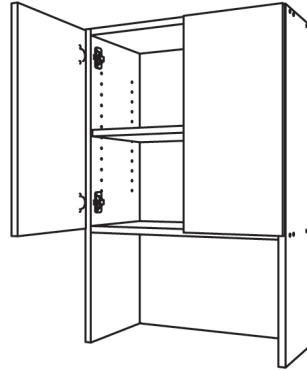

- CM442 - O**
Two-Door Hutch Cabinet
- One fixed shelf standard
 - Specify opening height
 - Specify number of adjustable shelves
 - Interior surface shall be as listed on order form unless noted differently

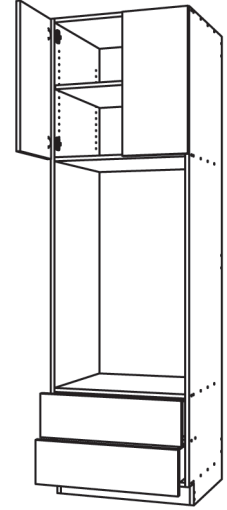

- CM822 - O**
Two-Door Open Tall Cabinet - Two Drawers
- Two fixed shelf standard
 - Specify drawer box and opening heights
 - Specify number of adjustable shelves
 - Interior surface shall be as listed on order form unless noted differently

- **S (Split Doors):** Give the inside height dimensions of the bottom section.
- **HP (Horizontal Partition):** Give the inside height dimensions of the bottom section.
- **D (Drawer Section):** Specify drawer front heights.
- **O (Open Appliance Section):** Specify inside dimensions for each section.

Specialty Parts

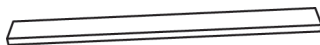

- CM910**
Base Filler
- Specify width and length

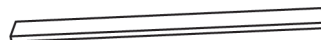

- CM930**
Upper Filler
- Specify width and length



- CM940**
Tall Filler
- Specify width and length

FACE FRAMES

FACE FRAME CONSTRUCTION

Butt Joint: Frames will be assembled using wood glue and high-strength pocket screws at all joints

Haunched: For added rigidity, haunched construction may be requested.
- If haunching is requested, all mid-stiles/mid rails will be 1-7/8" wide.
- Haunching will be used for all beaded frames.

Frames can be delivered unassembled, if preferred.

Haunch Construction

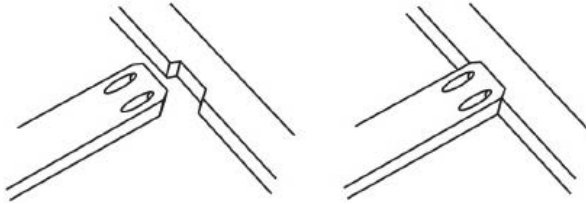

Bead Options

Square



Beaded

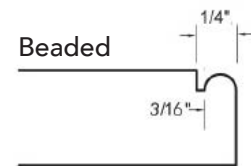

PART WIDTHS

Standard Stile/Rail Widths:
1-1/2", 2", 2-1/2", 3"

Haunched Mid Stile/Rail"
1-7/8"

For standard pricing, stile and rail widths must adhere to stated increments.
Option charges will apply to custom width requests.

MIN / MAX SIZES

For standard pricing, stile and rail widths must adhere to stated increments.
Option charges will apply to custom width requests.

MATERIALS

Corona Millworks offers face frames in Alder, Beech, Cherry, Poplar, Red Oak, Select Maple, Soft Maple, Walnut, and White Oak. Additional varieties can be requested, but availability may affect cost and lead time.

SANDING

All frames will be sanded on the face and back to 13/16".

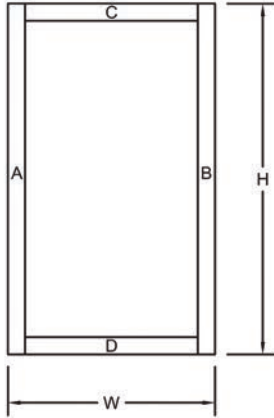

CMF-01

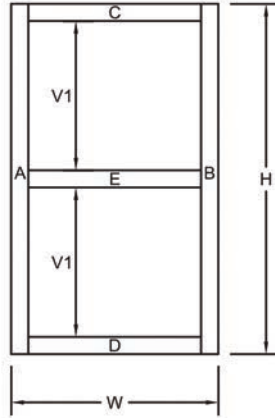

CMF-02

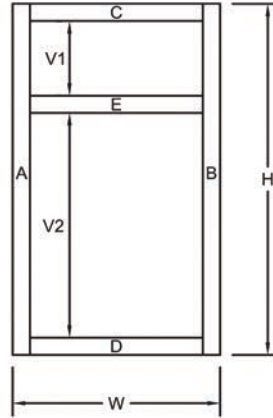

CMF-03

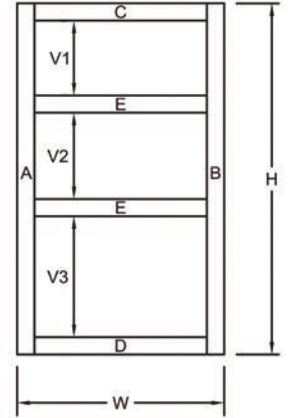

CMF-04

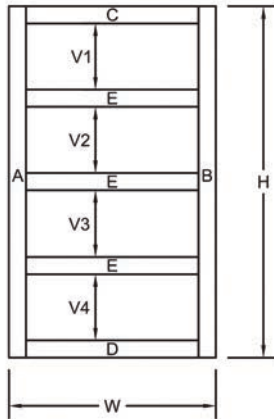

CMF-05

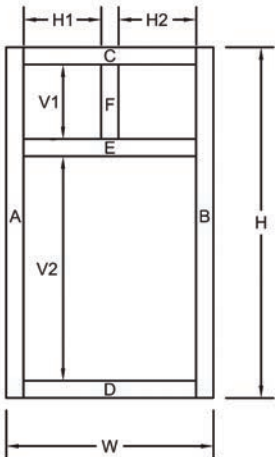

CMF-06

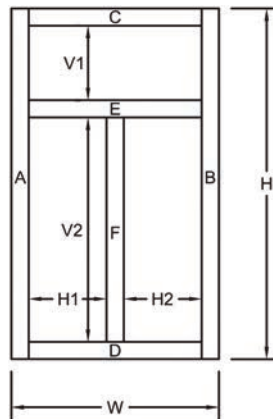

CMF-07

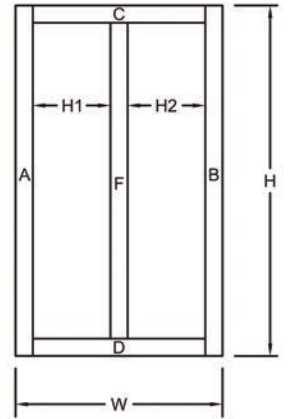

CMF-08

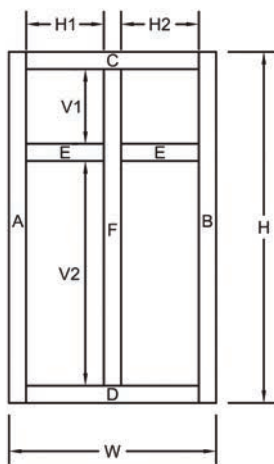

CMF-09

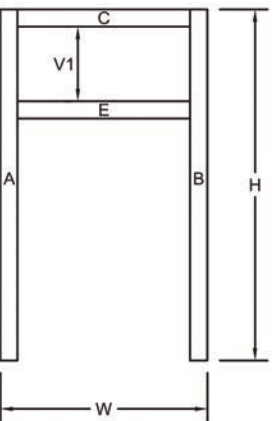

CMF-10

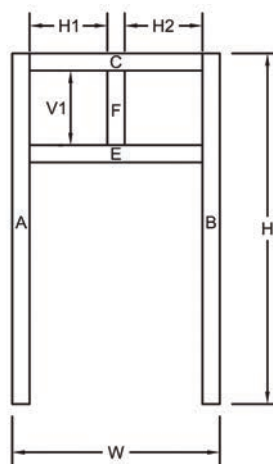

CMF-11



CMF-S
Custom Options Available

COMPONENTS





CORBEL COLLECTION WOOD POSTS PREMIUM MOULDINGS

These architectural accent pieces are both decorative and functional as island supports, shelf supports, and under-cabinet architectural embellishments. Wood posts are available in full posts, half-posts, unfinished, or pre-finished to your specifications. Our crown and baseboard mouldings are crafted from the finest materials including white and red oak, alder, maple, cherry, as well as paint grades.

CORBEL COLLECTION



Corbel-A-4
3-1/2" x 7-3/4" x 3"
Narrow
Acanthus
Bar Bracket

All Corbels Available in:
Cherry, Maple, Red Oak, Alder, Rubberwood



Corbel-A-3
6-3/4" x 7-3/4" x 22"
Large, Acanthus



Corbel-A-13
5-3/8" x 3-3/4" x 12-1/2"
Medium, Acanthus



Corbel-A-7
4-1/2" x 1-3/4" x 10"
Low Profile, Acanthus



Corbel-A-11
4-1/2" x 2" x 7"
Low Profile, Acanthus



Corbel-A-8
3" x 1-3/4" x 4-1/4"
Mini, Acanthus



Corbel-G-4
5" x 5-3/4" x 10"
Small, Grape



Corbel-G-5
3" x 9" x 12"
Narrow, Grape



Corbel-T-5



Corbel-T-2
5" x 7" x 14"
Medium, Traditional



Corbel-T-4
3-3/8" x 7-3/4" x 13"
Narrow, Traditional Bar Bracket



Corbel-BW-5



Corbel-BW-4
3" x 2" x 4-1/2"
Mini, Basket Weave



Corbel-BW-1
4-1/2" x 5" x 10"
Small, Basket Weave



Corbel-USA-1
4-5/8" x 4-5/8" x 10"
Small, Patriotic



Corbel-R-1
4-5/8" x 4-5/8" x 10"
Small, Rope



Corbel-M-2
3" x 9" x 12"
Medium, Mission



Corbel-M-4
2-1/2" x 6-1/2" x 12"
Narrow, Mission



Corbel-M-7
6-3/4" x 7-5/8" x 22"
Large, Mission

WOOD POSTS & MOULDINGS

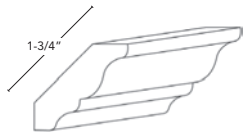

W-Crown #1

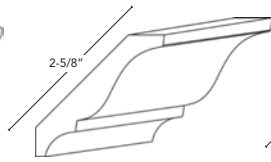

W-Crown #5

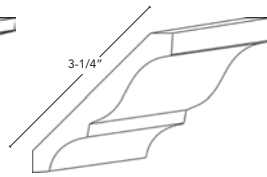

W-Crown #6

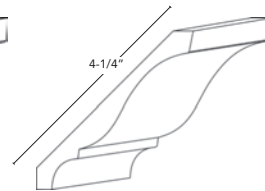

W-Crown #7

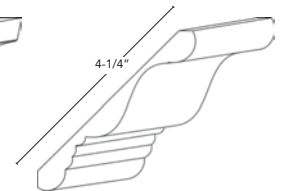

W-Crown #8

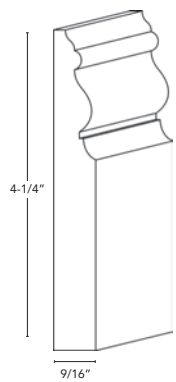

W-Base #3

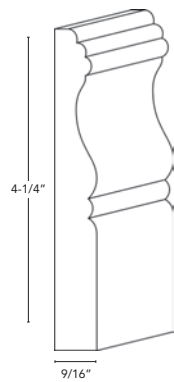

W-Base #2

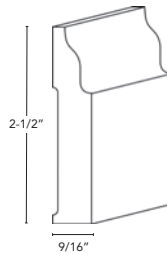

W-Base

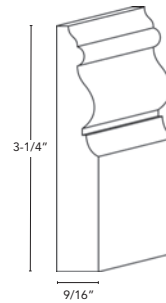

W-Base #1

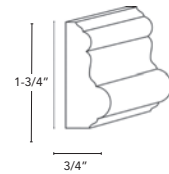

Light Rail

Full Post Sizes: 3-1/2" x 3-1/2" x 35-1/4", 3-1/2" x 3-1/2" x 42", 5" x 5" x 36" | Half Post Sizes: 1-3/4" x 3-1/2" x 35-1/4"

Post A



Post B



Post C



Post D



Post E



Post F



Post G



Post M







HARDWARE & FASTENERS

Corona Millworks offers a wide range of hardware options to help complete your cabinet assembly and installation. We offer the latest drawer slides and hinges (including soft-close options), a standard selection of knobs, handles, and pulls in addition to a wide range of back plates and quick screws.



K-110
30mm Knob
Satin Nickel



K-100
30mm Knob
Antique Black



K-120
30mm Knob
Oil Brushed Bronze



K-200
32mm Knob
Satin Nickel



K-210
32mm Knob
Oil Brushed Bronze



K-190
32mm Knob
Antique Black



K-150
1 3/8mm Knob
Brushed Bronze



K-130
1 3/8mm Knob
Weathered Nickel



K-140
1 3/8mm Knob
Satin Nickel



K-170
30mm Deco Knob
Satin Nickel



K-160
30mm Deco Knob
Weathered Nickel



K-180
30mm Deco Knob
Oil Brushed Bronze



P-100
Pull 3" CC
Antique Black



P-140
Pull 3" Deco CC
Satin Nickel



P-110
Pull 3" CC
Satin Nickel



P-150
Pull 3" Deco CC
Oil Brushed Bronze



P-120
Pull 3" CC
Oil Brushed Bronze



P-130
Pull 3" Deco CC
Weathered Nickel



Bar Pull
Satin Nickel
6" BP6-N

- | | | | |
|------------|------------|------------|------------|
| 8" BP8-N | 10" BP10-N | 12" BP12-N | 14" BP14-N |
| 16" BP16-N | 18" BP18-N | 20" BP20-N | 22" BP22-N |
| 24" BP24-N | 26" BP26-N | 28" BP28-N | 30" BP30-N |



P-96
Pull 96 mm CC Satin Nickel

P-128
Pull 128 mm CC Satin Nickel

Corona Millworks offers top quality hinge, slide, and clip hardware from Hettich®.

Large selection, smart mounting and options for any loading capacity, tried and true ball-bearing slides and hinges with the added convenience of soft-close features, Hettich® provides the perfect combination of intelligent technology, functionality and design.





HE-110-F
110 Degree Full Overlay



HE-110-FSC
110 Degree Full Overlay, Soft Close

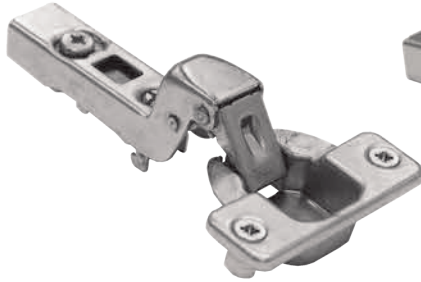

HE-110-I
110 Degree Inset



HE-125
125 Degree Full Overlay

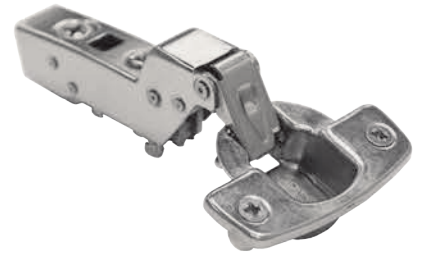

HE-110-ISC
110 Degree Inset, Soft Close

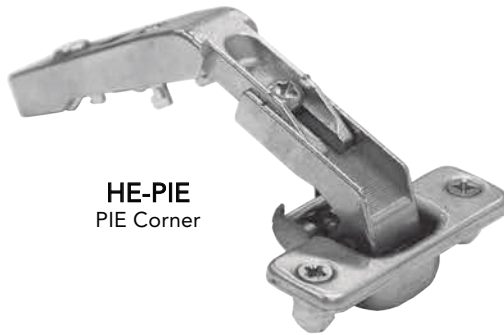

HE-PIE
PIE Corner

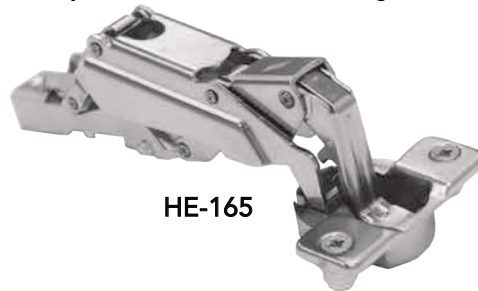

HE-165



HE-3MMFL

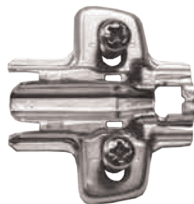

HE-0MMFL

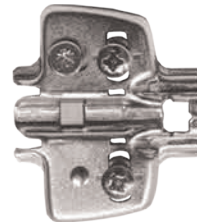

HE-3MMFLADJ
3mm Frameless
Adjustable Plate
CAM



HE-0MMFLADJ
0mm Frameless
Adjustable Plate
CAM

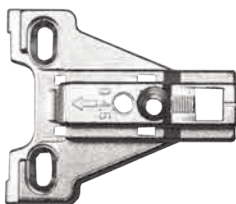

HE-45MMFF
4.5mm Face Frame Plate

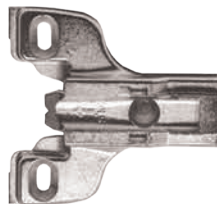

HE-45MMFFSC
4.5mm Face Frame Plate
Soft Close

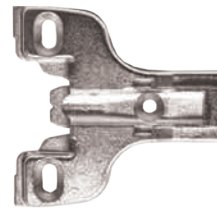

HE-0MMFFSC
0mm Face Frame Plate
Soft Close

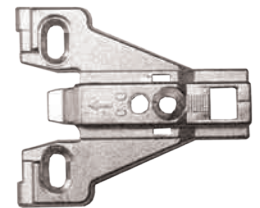

HE-0MMFF
0mm Face Frame Plate

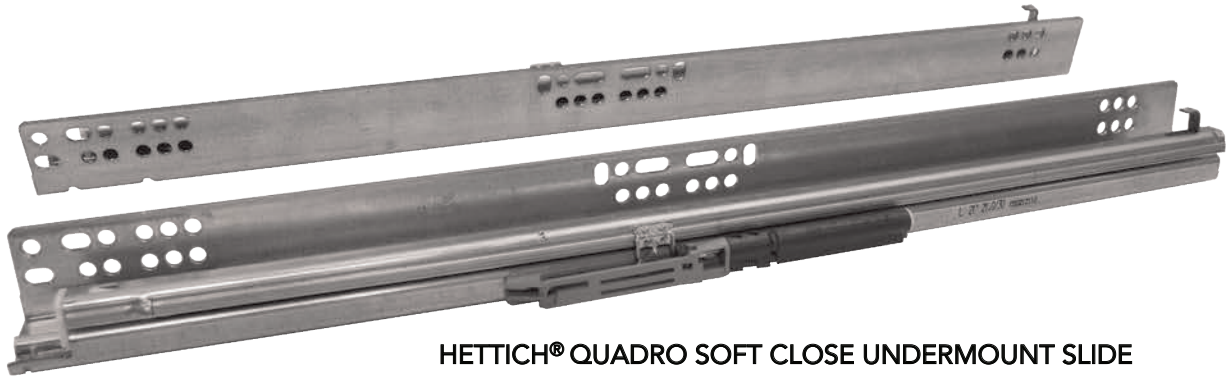

HETTICH® QUADRO SOFT CLOSE UNDERMOUNT SLIDE



HETTICH® QUADRO 4D ADJUSTABLE
SOFT CLOSE UNDERMOUNT SLIDE



HETTICH® CLIPS & BACK PLATES



▲ **CONFIRMAT SCREW**
70mm x 50mm
SC-50-1H (Qty 100)
SC-50-1K (Qty 1000)



▲ **BREAKAWAY SCREW**
#8-32 x 1 3/4"
SB-134-1H (Qty 100)
SB-134-1K (Qty 1000)



▲ **UNDERCUT HINGE & DRAWER SLIDE SCREW**
#6 x 7/16" (Qty 100) SHD-716-1H
#6 x 7/16" (Qty 1000) SHD-716-1K
#6 x 1/2" (Qty 100) SHD-12-1H
#6 x 1/2" (Qty 1000) SHD-12-1K



▲ **ASSEMBLY SCREW**
#8 x 1" Type 17 (Qty 100) ST17-1-1H
#8 x 1" Type 17 (Qty 1000) ST17-1-1K
#8 x 1 1/4" Type 17 (Qty 100) ST17-114-1H
#8 x 1 1/4" Type 17 (Qty 1000) ST17-114-1K
#8 x 1 1/2" Type 17 (Qty 100) ST17-112-1H
#8 x 1 1/2" Type 17 (Qty 1000) ST17-112-1K
#8 x 1 5/8" Type 17 (Qty 100) ST17-158-1H
#8 x 1 5/8" Type 17 (Qty 1000) ST17-158-1K
#8 x 2" Type 17 (Qty 100) ST17-2-1H
#8 x 2" Type 17 (Qty 1000) ST17-2-1K
#8 x 2 1/2" Type 17 (Qty 100) ST17-212-1H
#8 x 2 1/2" Type 17 (Qty 1000) ST17-212-1K
#8 x 3" Type 17 (Qty 100) ST17-3-1H
#8 x 3" Type 17 (Qty 1000) ST17-3-1K



▲ **DRAWER FRONT ADJUSTING SCREW**
#8 x 7/8" (Qty 100) SDF-78-1H
#8 x 7/8" (Qty 1000) SDF-78-1K
#8 x 1" (Qty 100) SDF-1-1H
#8 x 1" (Qty 1000) SDF-1-1K
#8 x 1 1/8" (Qty 100) SDF-118-1H
#8 x 1 1/8" (Qty 1000) SDF-118-1K
#8 x 1 1/4" (Qty 100) SDF-114-1H
#8 x 1 1/4" (Qty 1000) SDF-114-1K



▲ **EUROPEAN SLIDE SCREW**
6.3mm x 10.5mm
SE-105-1H (Qty 100)
SE-105-1K (Qty 1000)



▲ **LOW PROFILE DRAWER SLIDE SCREW**
#8 X 1/2"
SLD-12-1H (Qty 100)
SLD-12-1K (Qty 1000)



▲ **2 TIER LAZY SUSAN**
Kidney Shaped
28" or 32"



▲ **5mm NICKEL SPOON-SHAPED SHELF PIN**
PIN-5 (Qty 100)



▲ **3/8" x 1/16" CLEAR BUMPER**
CLR-BUM (Qty 450)



▲ **3/4" SPACERS**
SPCR

INDEX

CATALOG QUICK REFERENCE INDEX

CABINET COMPONENTS & PARTS	106 - 117
100 Series - Base Cabinets	108 - 109
140 Series - Base Cabinets	108
150 Series - Base Cabinets	109
200 Series - Base Cabinets with Drawers	110
200 Series - Drawer Aprons	111
300 Series - Upper Cabinets	111 - 112
400 Series - Tall Cabinets	113-114
800 Series - Tall Cabinets	114
Cabinetry Detail Illustrated	107
Face Frames	116 - 117
Specialty Cabinets	115
Specialty Parts	115
CORBEL COLLECTION	120
DRAWER BOXES & CUSTOM INSERTS	100 - 103
DRAWER SLIDES & CLIPS	128
E-SERIES	67 - 71
HINGES & PLATES	127
KNOBS	124
MOULDINGS	129
PULLS	125
QUICK SCREWS, SPACERS & PINS	129
THERMOFOIL SERIES	73 - 97
WOOD DOOR SERIES	7 - 65
WOOD POSTS	121

DOOR SECTIONS INDEX

E-SERIES DOORS	67 - 71
E-Series Color Options	70
E-Series Size & Materials Specs.	71
HIGH DEFINITION TEXTURED MELAMINE	69
TM-100-H	69
TM-100-V	69
TM-300-H	69
TM-300-V	69
TM-500-H	69
TM-500-V	69
ULTRA HIGH GLOSS ACRYLIC	68
A-100-H	68
A-100-V	68
A-300-H	68
A-300-V	68
VENEER	68
V-050-H	68
V-050-V	68
V-100-V	68
V-100-H	68
V-300-H	68
V-300-V	68
THERMOFOIL DOORS	73 - 97
Thermofoil Color Options	93 - 97
Thermofoil Door Profiles	90 - 91
Thermofoil Edge Detail	89
Thermofoil Fingerpull Options	88
Thermofoil Moulding Options	89
CM 63	74
CM 69	74
CM 100	74
CM 131	74
CM 181	75
CM 182	75
CM 300	75
CM 400	75
CM 500	76
CM 527	76
CM 530	76

THERMOFOIL DOORS - CONTINUED . . .

CM 540	76
CM 570	77
CM 700	77
CM 712	77
CM 714	77
CM 716	78
CM 722	78
CM 731	78
CM 732	78
CM 742	79
CM 744	79
CM 746	79
CM 756	79
CM 757	80
CM 758	80
CM 766	80
CM 767	80
CM 768	81
CM 775	81
CM 776	81
CM 777	81
CM 782	82
CM 783	82
CM 785	82
CM 800	82
CM 807	83
CM 810	83
CM 819	83
CM 842	83
CM 844	84
CM 846	84
CM 877	84
CM 942	84
CM 944	85
CM 946	85
CM 977	85
CM 979	85
CM 980	86

THERMOFOIL DOORS - CONTINUED . . .

CM 981	86
CM 982	86
CM 1210	86
CM 1220	87
CM 1230	87
CM 1345	87
CM 2210	87
CM 2220	88
CM 2230	88

WOOD DOORS 7 - 65

Wood Door Edge Detail Options	63 - 65
Wood Mouldings	89
CONTEMPORARY SERIES	58
Contemporary Series Door Profiles .	58
Amsterdam	58
European	58
Savannah (Batten)	58
DESIGNER SERIES	21 - 31
Designer Series Door Profiles .	30 - 31
Acquario	29
Alexander	25
Alexis	25
Antigua	22
Arroyo	24
Bahia	22
Bellflower	24
Brooks	23
Captiva	27
Coronado	22
Cranley	26
CS 467	25
Elite	24
Emily	27
Hanover	28
Harvest	29
Hughes	26
Lakewood	24
Mallaga	23
Modesto	28

WOOD DOORS - CONTINUED . . .

Montego	22
Pismo	23
Placentia	29
Puffy	28
Riverton	27
Santa Rosa	23
Scottsdale	26
Sequoia	29
Snowden	28
Sylvan	25
Tuscany	27
Villa Maria	26
LOUVER SERIES	59
Louver Series Door Profiles	59
Cabrillo	59
Donovan	59
Easton	59
MITERED SERIES	33 - 47
Mitered Series Door Profiles	46 - 47
Amber	44
Arizona	42
Atlanta	45
Barton	43
Bella Vista	45
Belmont	43
Boyd	34
Cambria	41
Carmel	34
Castlewood	35
CM 410	42
Cortina	38
Crestview	43
Daytona	37
Derby	41
Diplomat	37
Dorado	41
Emerald	42
Florence	42

WOOD DOORS - CONTINUED . . .

Gardenia	35
Georgia	45
Graham	36
Hemet	44
Hermosa	35
Huntington	34
Koper	38
Laguna	35
Manchester	41
Monte Carlo	43
Nathan	39
Newport	36
Ogden	39
Panama	36
Pipeline	39
Rancho	34
Rio	37
Samantha	39
Sandy	44
Santa Cruz	36
Shelby	37
Sierra	34
Sunset	44
Tanyr	44
Venice	36
Vista	45
Wesley	38
Weston	38
Winston	35
MOULDING SERIES	49 - 55
Moulding Series Door Profiles	55
Alina	51
Brock	53
Carlton	50
Cascade	51
Cheyenne	53
Harrison	53
Horizon	50

WOOD DOORS - CONTINUED . . .

Jackson	50
Jane	52
Justin	52
Melbourne	54
MLD 33	53
MLD 446	52
Pinnacle	54
Raya	54
Sara	51
Sheridon	50
Strager	51
Zorn	52
SPECIALTY OPTIONS	60 - 61
Angle Door	60
Eyebrow Arch	60
Glass Door 4 Lites	61
Glass Door 9 Margin Lites	61
Half Circle Arch	60
Outer Frame Eyebrow 7 Lites	61
Radius Frame	60
STANDARD SERIES	7 - 19
Standard Series Door Profiles	18-19
Albany	8
Andromeda	15
Ariel	11
Arlington	17
Arvada	16
Ashley	8
Astron	9
Aurora	14
Barbour	17
Bonny	17
Columbus	17
Corvus	14
Durham	8
Galaxy	9
Gamma	11
Gemini	15

WOOD DOORS - CONTINUED . . .

Harley	15
Helio	14
Jovian	16
Jupiter	10
Libra	14
Lunar	10
Madison	8
Nicolaus	11
Orion	9
Pavo	11
Phoenix	15
Priscilla	13
Rubio	13
Saturn	9
Serena	13
Sol	10
Triton	16
Vega	10
Venus	16
Victoria	13



Cabinet Doors & Drawer Boxes

Wood Doors | Thermofoil Doors | Drawer Boxes
Cabinet Components | Hardware & More

CONTACT SALES
800-200-0975

FAX
909-606-3270

OFFICE
909-606-3288

ORDER ONLINE
CoronaMillworks.com

CATALOG VOLUME #2017-1